

HOUSE OF
DURATECH
innovative pool products

Manual

PLP-REM-350

English.....Page 3
Nederlands.....Pagina 21
Français.....Page 39
Deutsch.....Seite 57
Español.....Página 75



17-11-20

LINK Driver

Table of contents

Technical specifications	
General Specifications	Page 4
PLP-REM-350 overview	Page 4
Logic board	Page 5
Installation Instructions	
Single PLP-REM-350 unit	Page 6
Multiple PLP-REM-350 installation.....	Page 7
Operation modes	Page 8
DIP switch functionalities	Page 9
Transmitter functions	
Operation mode: PLC	Page 10
Operatio mode: ON/OFF.....	Page 10
Replacing transmitter keypad.....	Page 11
Pairing the handheld transmitter	Page 11
DMX 512 communication	
Single PLP-REM-350 unit	Page 12
Multiple PLP-REM-350 installation	Page 13
RS-485 communication	
Single PLP-REM-350 unit	Page 14
RS-485 command set.....	Page 15
RESET procedure	Page 16
Transmitter battery.....	Page 16
Troubleshooting.....	Page 17
Pool light wiring instructions	Page 18
Wiring remark	Page 20

DURALINK

Technical specifications

General specifications

Input Voltage:	230 VAC 50Hz
Output Voltage:	12 VAC
Transformer VA rating:	350VA
Max output Power:	350 VA (12 VAC / 25A)
Max rating relay contact A &B	16A / 250 VAC
Max switching power A & B	4000VA
RF band	868 MHz
Ambient Air Temperature:	0°C to +40°C
Humidity	10% to 90% RH - non condensing
Ingress protection rate:	IP54
IEC Protection Class:	Class II <input type="checkbox"/>

PLP-REM-350 overview

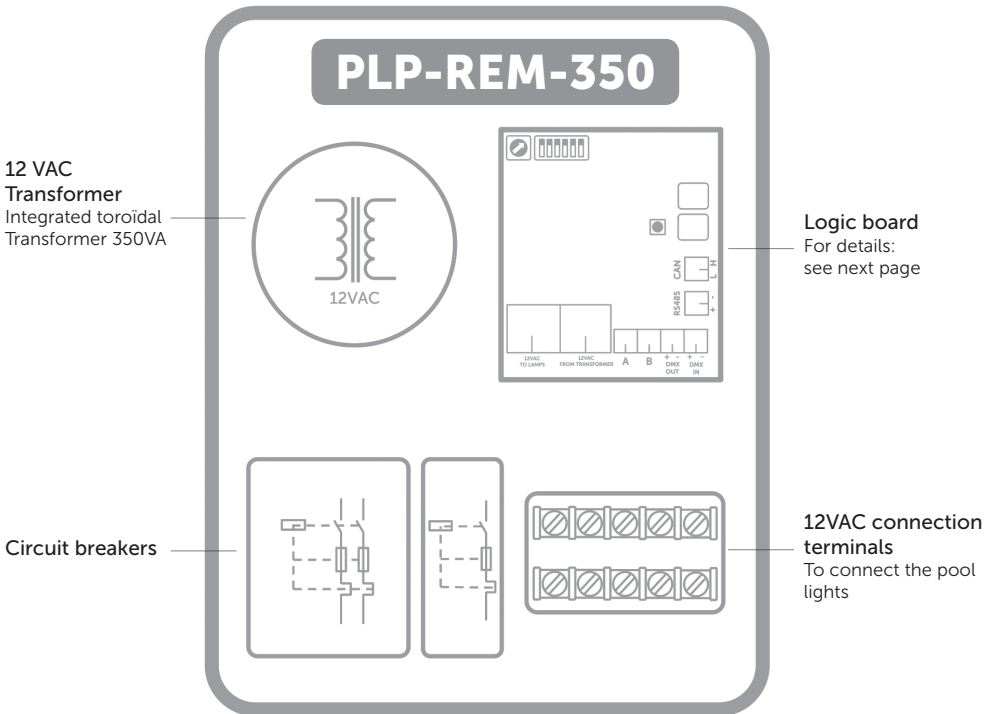

Logic board

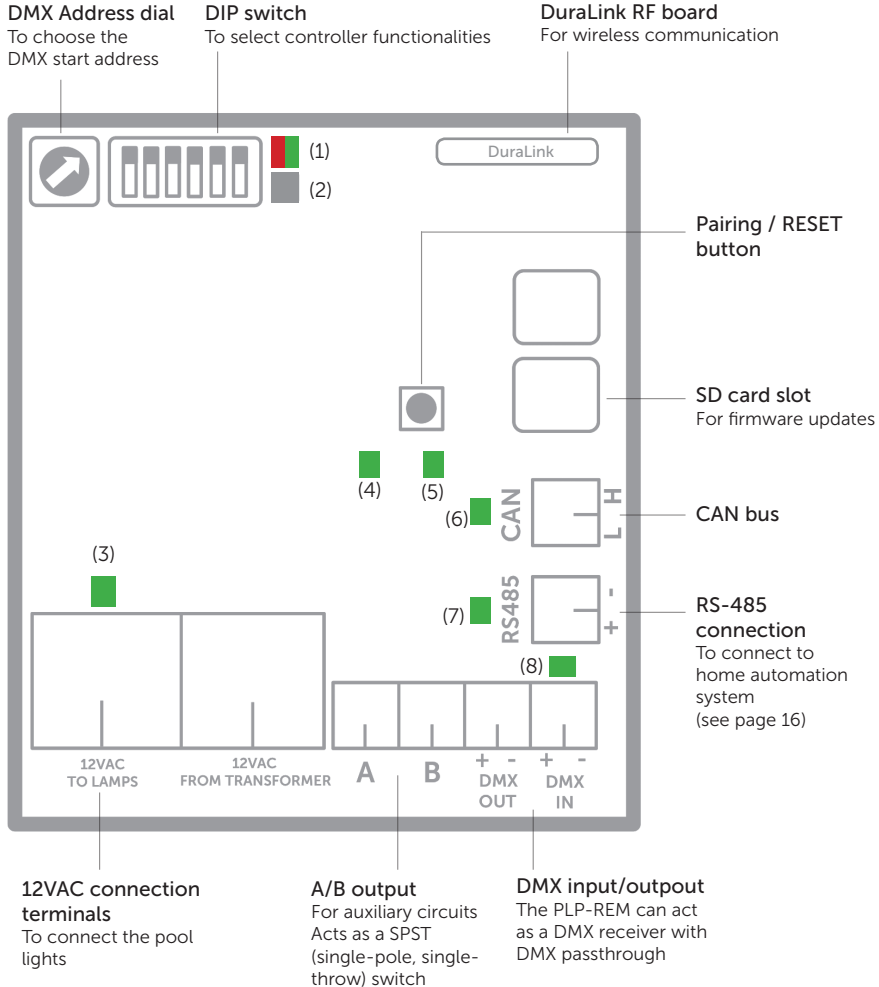

Status LED's:

- (1) General status
Green = OK
Red = error overvoltage or overcurrent
- (2) Pairing / RESET status
- (3) 12VAC to Pool lamps (Green = ON)
- (4) Switch A (Green = ON)
- (5) Switch B status (Green = ON)
- (6) CAN status
- (7) RS-485 signal
- (8) DMX signal

Installation Instructions

Single PLP-REM-350 unit

- Connect a 230VAC power source to the 230VAC terminals of the PLP-REM-350. Connect the pool lights to the 12VAC connection terminal block in the PLP-REM-350.
- The PLP-REM-350 has a 350VA transformer built in. The total power load of pool lights (+ cable losses) may not exceed this.

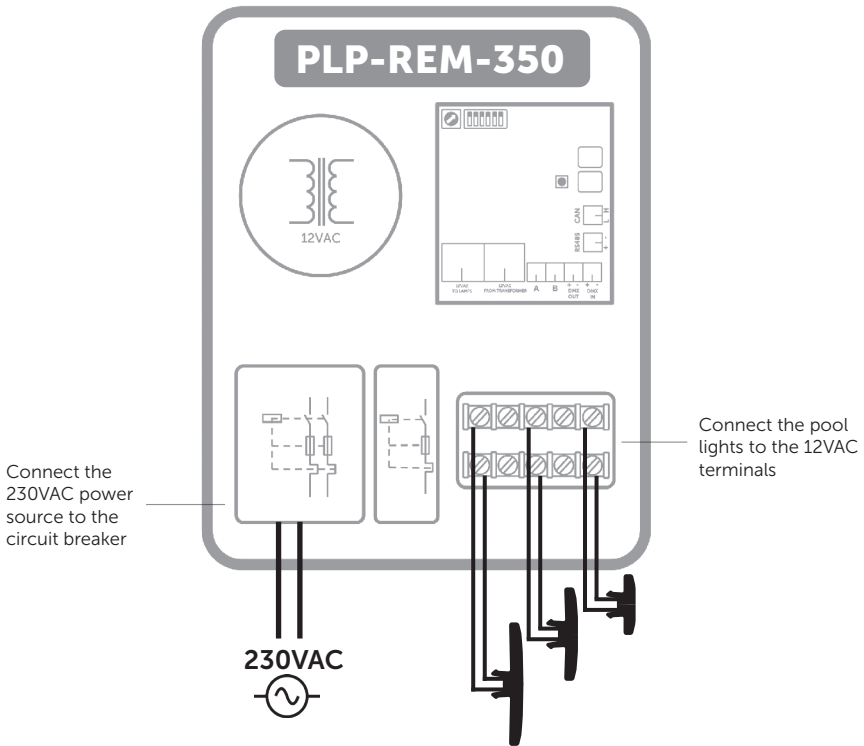

Multiple PLP-REM-350 installation

For extended installations (total lamp power > 350VA), multiple PLP-REM-350's can be linked together. This way, a perfect synchronisation of all pool lights is still guaranteed.

The PLP-REM-350's need to communicate with each other, to ensure all the lamps are in perfect sync.

Connect the PLP-REM-350's with each other using the CAN bus: Connect the CAN terminals of the first PLP-REM-350 with the CAN terminal of the second PLP-REM-350*.

If more than 2 PLP-REM-350's are necessary, simply daisy chain each CAN terminal with the one from the next PLP-REM-350 (see below).

Respect the polarity of the terminals! (CAN L & H)

Next, set the DIP switches on the PLP-REM-350's to the correct MASTER/SLAVE setting. The first PLP-REM-350 will be the MASTER. All the others will be SLAVE's. Refer to page 9 for Master/Slave DIP switch info.



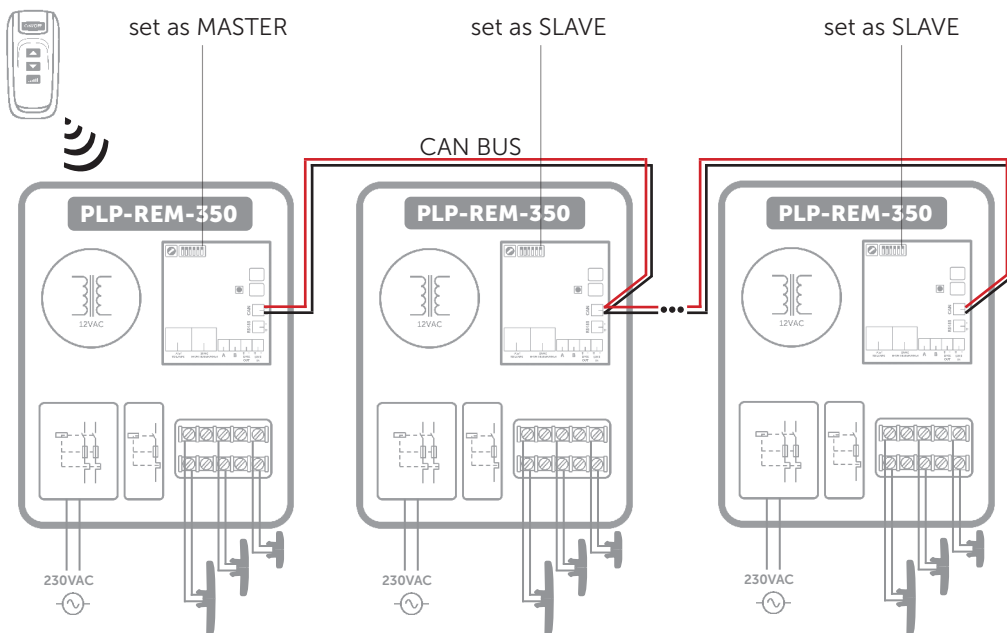







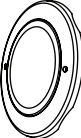

 In a Master/Slave setup, only the PLP-REM-350 that is set as MASTER will react to transmitter commands. Any additional transmitters will need to be paired with this MASTER PLP-REM-350



* We recommend using a shielded twisted pair cable (min. 0,5mm² - up to 200m) to connect multiple PLP-REM-350's using the CAN bus.

Operation Modes

The PLP-REM-350 controller has 2 main operation modes: "ON/OFF control mode" & "PLC control mode". Each mode has it's own functionalities:

	ON/OFF	PLC
Compatible lamps	 VISION Adagio Pro  VISION Spectra  VISION Moonlight	 VISION Adagio Pro  VISION Pro
Switch lamps ON/OFF	YES	YES
Change lamp color	YES ⁽¹⁾	YES ⁽¹⁾
Operate Relay A & B	YES	YES
Dimming lamps	NO	YES ⁽¹⁾
DMX control	NO	YES
RS-485 control	YES ⁽²⁾	YES
Dip switch setting	DIP 1 ON	DIP 1 OFF
Remote keypad type ⁽³⁾	   	   

1) Only for RGB lamps

2) In ON/OFF control mode, only a few RS-485 commands are available (see p 15)

3) Depending on which control mode is selected, the keypad of the transmitter needs to be changed

DIP switch functionalities

The DIP switch on the main circuit board of the PLP-REM-350 allows the user to customise the way the PLP-REM-350 operates.

! CAUTION: Always switch off the main power supply to the PLP-REM-350 before changing the DIP switches

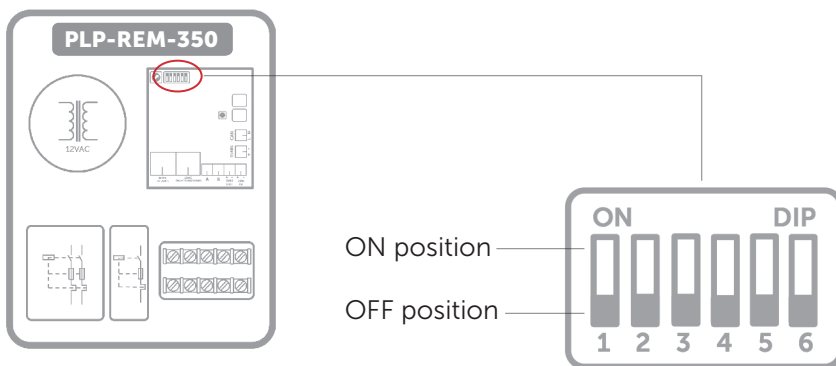

		DIP SWITCH					
function	setting	1	2	3	4	5	6
Operation Mode	ON/OFF	ON					
	PLC	OFF					
Relay A	PULSE mode		ON				
	TOGGLE mode		OFF				
Relay B	PULSE mode			ON			
	TOGGLE mode			OFF			
Fast DMX setting *	FAST				ON		
	STANDARD				OFF		
DMX	NO LOOP					ON	
	LOOP					OFF	
MASTER/SLAVE mode	SLAVE						ON
	MASTER						OFF

* Fast DMX setting
Only for Adagio Pro lamps from 2018 and onwards

Transmitter functions

OPERATION MODE: PLC (default mode)

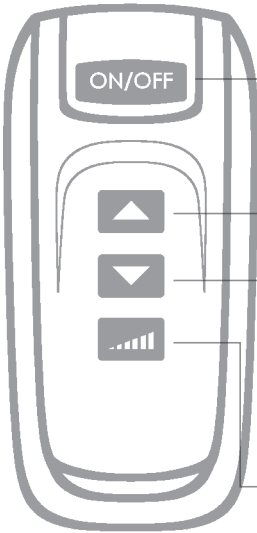

Short push (< 1 sec):

Toggle all lamps ON or OFF ⁽¹⁾

Long push (> 2 sec⁽²⁾):

All lamps & "12VAC TO LAMPS" relay are turned OFF ⁽¹⁾

Short push:

Go to next color program

Long push:

Toggle output A ON/OFF

Short push:

Go to the previous color program

Long push:

Toggle output B ON/OFF

Short push:

Select next dimming level:

100% -- 50% -- 25% ---> 100% -- ...

Long push:

Set lamps to Program 1 (blue) & full brightness

OPERATION MODE: ON/OFF

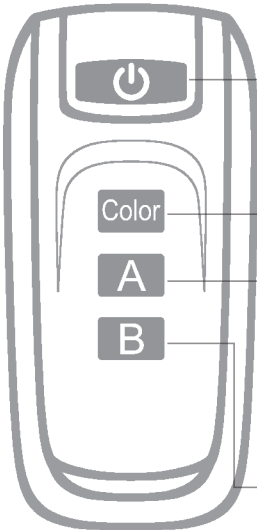

Short push (< 1 sec):

Toggle all lamps ON or OFF

Short push:

Go to next color program

Long push:

Auto sync procedure ⁽³⁾

Short push:

Toggle output A ON/OFF

Long push:

/

Short push:

Toggle output B ON/OFF

Long push:

/

(1) Lamp ON or OFF status is memorized after power down

(2) The green LED in the transmitter will light up as soon as you start pressing a button, and will stop after 2 seconds, so you know exactly when to release the button.

(3) The lamps will be turned off for 30 seconds and then switched ON/OFF 3 times. This will set all lamps to program 1: blue

Replacing transmitter Keypad

Depending on which control mode is selected, the keypad of the transmitter needs to be changed:

- Remove the philips head screw and open the transmitter
- Replace the Keypad in the top part of the transmitter housing
- Reassemble in reverse order

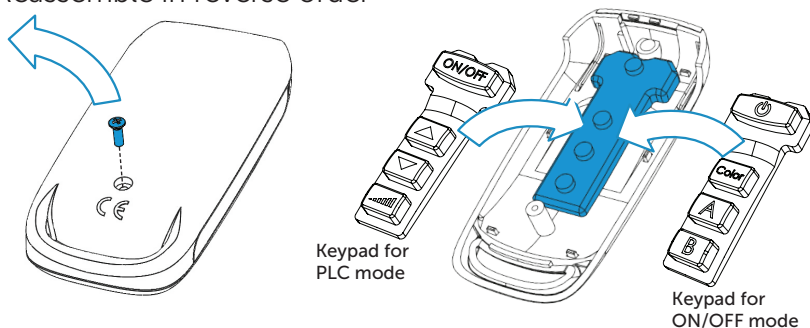

Pairing the handheld transmitter to the PLP-REM-350

All handheld transmitters are already paired in the factory and ready to use. In case a problem arises, the pairing process can be done as below:

- 1) Press the pairing button on the circuit board, inside the PLP-REM-350
 ---> The BLUE LED will start to blink
- 2) Within 25 seconds, push any button on the handheld transmitter.
 ---> If the remote is paired correctly, the BLUE LED will flash slowly for 5 times
 ---> **UNPAIRING:**
 See RESET procedure: page 16

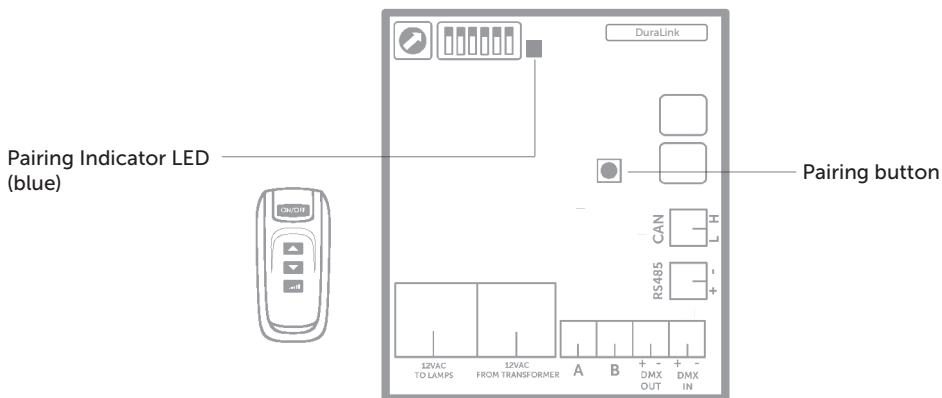

DMX 512 communication

Single PLP-REM-350 unit

- 1) Make sure DIP switch 1 is switched OFF.
- 2) Make sure the lights are turned ON with the remote first.

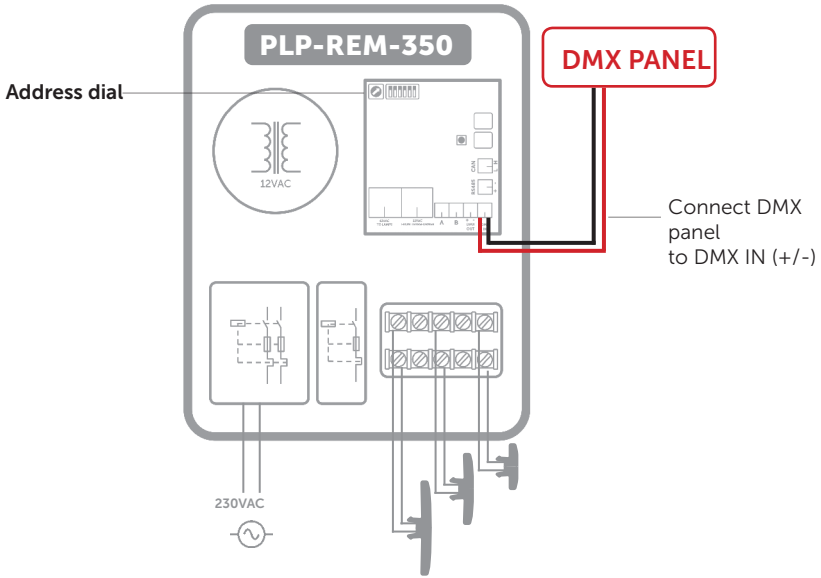

Address dial setup

Setting the DMX address of the PLP-REM-350:
 Select the desired number on the address dial. The chosen number determines the DMX addresses of the PLP-REM-350 & lamps.
 Each lamp uses 3 bytes of DMX data (R-G-B), and all lamps receive the same DMX data from the PLP-REM-350.

Address dial position	0			1			2			...
	R	G	B	R	G	B	R	G	B	...
DMX address	1	2	3	4	5	6	7	8	9	...

The DMX start address can be overruled by using the RS-485 command: "set DMX start address" (see page 17)

! Remark:

When in DMX512 operation, the handheld transmitter can still select one of three dimming levels and can still switch the lamps. This can not be overridden by DMX512 data.

Multiple PLP-REM-350 installation

- 1) Connect the DMX panel to the "DMX IN" port of the first PLP-REM-350
- 2) Connect the PLP-REM-350's with each other (open loop):
DMX OUT --> DMX IN (polarized terminals + -)
- 3) Set the DMX address for each PLP-REM-350 via the address dial.
 - Option 1: All PLP-REM-350's can be set to the same address:
This implies that all lamps will receive the same DMX data,
And will all operate identically
 - Option 2: PLP-REM-350's can be set to different addresses:
Each PLP-REM-350 will have it's own group of connected lamps
that will operate identically.
However, since each PLP-REM-350 has it's own unique address,
the different lamp groups can be controlled separately

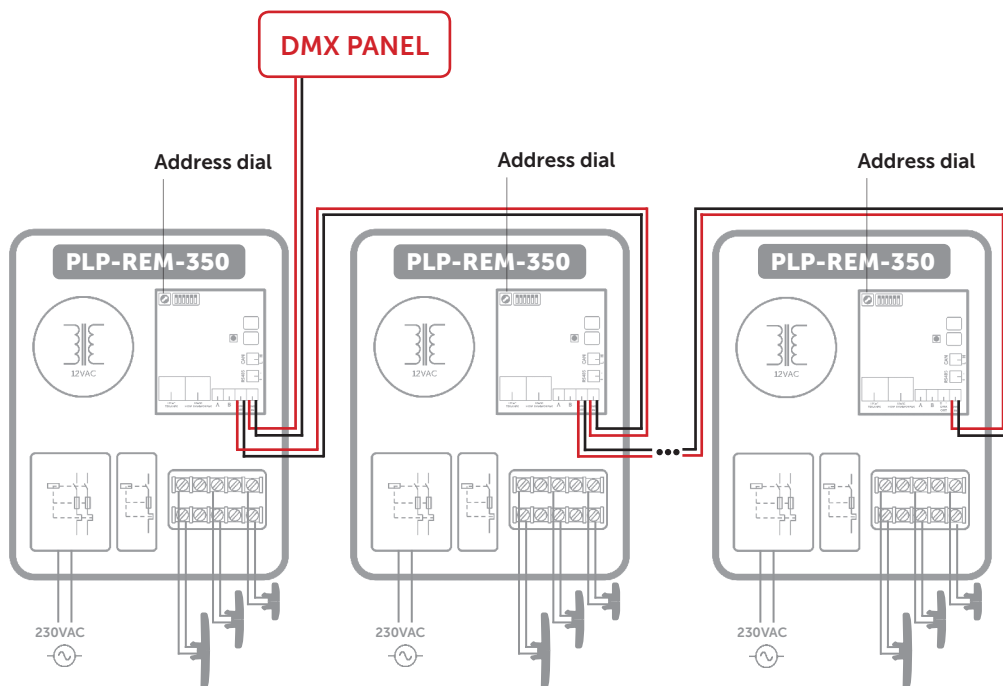

RS-485 communication

Single PLP-REM-350 unit

- 1) Make sure DIP switch 1 is switched OFF.
- 2) Make sure the lights are turned ON with the remote first.
- 3) Connect the RS-485 source to the "485" port on the PLP-REM-350
- 4) Communication settings: 9600, 8, 1, n
- 5) Command list: see page 15

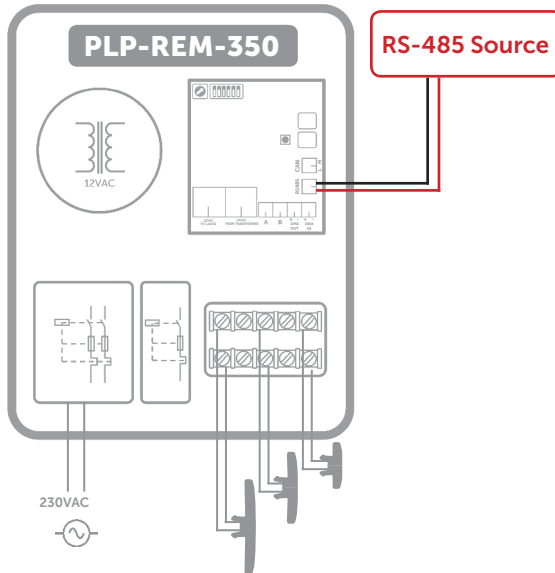

Multiple PLP-REM-350 installation

- 1) Connect the PLP-REM-350's with each other via the CAN bus (see page 7)
- 2) Make sure DIP switch 1 is switched OFF
- 3) Make sure the lights are turned ON with the remote first.
- 4) Connect the first PLP-REM-350 with the RS-485 source like described above. This PLP-REM will be the Master.
- 5) Communication settings & command list: see page 15

RS-485 Command set

Command	Command	Remark	Example	available in ON/OFF mode	available in PLC mode
Lamps OFF	PL0	All lamps OFF		X	X
Lamps ON	PL1	All lamps ON		X	X
Program UP	PsU	Jump to next program		X	X
Program Down	PsD	Return to previous program			X
Set Program	PSxx	xx is the decimal representation of the program number (01 - 14)	PS06 = jump to program 6		X
Auto sync procedure	PsS	executes the auto sync procedure (see page 10)		X	X
White 1	PW1	Jump to White 1 (program 12)			X
White 2	PW2	Jump to White 2 (program 13)			X
White 3	PW3	Jump to White 3 (program 14)			X
Set RGB	PCrrrgggbbb	rrr, ggg and bbb are the decimal representation of the RGB value (with leading zero's)	1) PC255128064 = Full output level on Red color, half output level on Green color, 1/4 output level on Blue color 2) PC255252555 = All colors at full output level 3) PC000000000 = All colors OFF		X
Set Dim value	PDxxx	set the OUTPUT value of the lamp in % (000 - 100)	PD075 = 75% output level (on all LEDs)		X
set DMX startAddress	PAxxxxyz	y = 'e' or 'E'	PA035E = set DMX start address to 35 [35(R), 36(G), 37(B)]		X
Set color in percentage	Pprgbe	variable size, rgb = ASCII 0-255, e = end character	Pp25050100e = Red 25%, Green 50%, Blue 100%		X
Set color in hex	Pcrgbe	variable size, rgb = ASCII 0-255, e = end character	Pc64128255e = Red 25%, Green 50%, Blue 100%		X
Relay A control	PRAx	x = 1 (ON), 0 (OFF), P (Pulse) this overrides dipswitch	PRA1 = Relay A ON PRA0 = Relay A OFF	X	X
Relay B control	PRBx	x = 1 (ON), 0 (OFF), P (Pulse) this overrides dipswitch	PRB1 = Relay B ON PRB0 = Relay B OFF	X	X
ON/OFF relay control	PRMx	x = 1 (ON), 0 (OFF)	PRM1 = Relay ON/OFF control ON	X	X
Color temperature	PTxyz	x = ten thousand ; y = thousand ; z = hundred	PT035 = Set white color temperature to 3500K (in steps of 500K)		X

RESET procedure

RESET procedure for the control board

- 1) Make sure the PLP-REM-350 is powered ON
- 2) Press and hold the RESET button on the logic board
- 3) The blue LED will light up
- 4) Release the RESET button when the blue LED turns off

 *The control board has been RESET.
And all transmitters have been unpaired.*

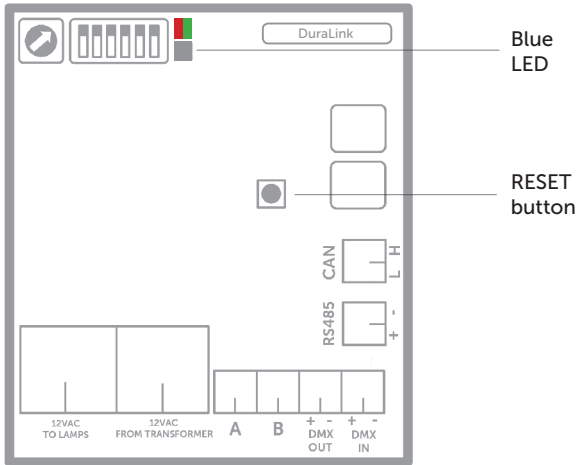

Transmitter battery

Replacing transmitter battery:

- Remove the philips head screw and open the transmitter
- Replace the battery, respecting the polarity

Battery type: A23 12V

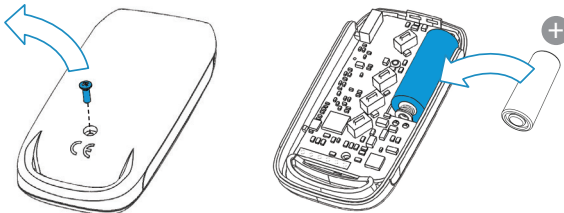

Troubleshooting

PROBLEM

The PLP-REM-350 doesn't react to transmitter commands

SOLUTION

- Perform a RESET procedure
- Check the battery of the handheld transmitter (see p.16)
- The transmitter is not paired-correctly with the PLP-REM. Repeat the pairing process
- Reduce the distance between handheld transmitter and PLP-REM-350 and/or remove obstacles
- Check the General status light on the logic board. If it's red, then the secondary voltage is too high (>14VAC) or there is a short circuit
- Check the LED on the small DURA-LINK circuit board (top right corner). This LED needs to blink each time a transmitter button is pressed. If the LED works, there might be a problem with the logic board

The pool lights don't work or don't change colors correctly

- Perform a RESET procedure
- Check if all connections are made according to the electrical scheme.
- Switch the PLP-REM-350 to ON/OFF mode (DIP switch nr 1) and check if the lamps work

Handheld transmitter does not function anymore after firmware update of the PLP-REM-350 for LinkTouch compatibility

- Buy a new TX868 transmitter that has updated firmware

Pool light wiring instructions



WARNING



- GB **Cable installation guidelines**
- NL **Richtlijnen voor bekabeling**
- DE **Anleitung zur Verkabelung**
- FR **Instructions de câblage**
- IT **Istruzioni di collegamento**
- ES **Instrucciones para ajuste del cableado**

Please refer to the manual of your DURAVISION® pool light



Manual downloads:
www.duratech.be/downloads

Not following the instructions for cable cross section and transformer VA ratings may result in lamp malfunctioning and may result in having to rewire the installation. The manufacturer's warranty does not apply in this situation.

Please refer to the manual of your DURAVISION pool light for detailed information about cable cross section and maximum length.

Wiring remarks

1. Third party equipment such as frequency inverters and electric motors can generate excessive noise on the 230VAC / 400VAC power line. This noise might be injected into the adjacent 12VAC power line and disturb the power line communication towards the DURAVISION lights.

 Keep 230VAC / 400VAC power line cables at least 50cm separated over their full length from the 12VAC power line towards any RGB lights

 Do not mix 12VAC and 230VAC / 400VAC power line cables into the same cable trays

2. Floating cores in a multi-core cable are not allowed because it disturbs PLC communication.

 We recommend using 2 CORE cables for all Adagio Pro lights to avoid PLC communication issues

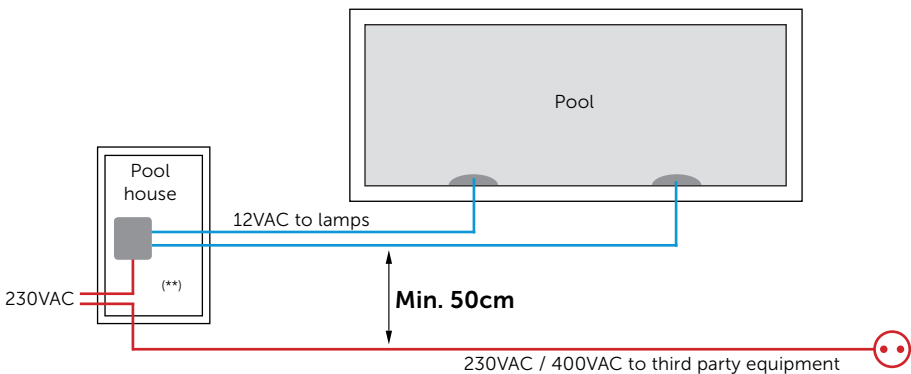

(**) Do not mix 12VAC and 230VAC / 400VAC power line cables into the same cable trays

Inhoudstafel

Technische specificaties	
Algemene Specificaties.....	Pagina 22
PLP-REM-350 overzicht.....	Pagina 22
Controller board.....	Pagina 23
Installatie Instructies	
Enkele PLP-REM-350 unit.....	Pagina 24
Installatie met meerdere PLP-REM-350's.....	Pagina 25
Werkingsmodus.....	Pagina 26
DIP schakelaar functies.....	Pagina 27
Afstandsbediening functies	
Werkingsmodus: PLC.....	Pagina 28
Werkingsmodus: AAN/UIT.....	Pagina 28
Klavier van afstandsbediening vervangen.....	Pagina 29
Afstandsbediening en controller koppelen.....	Pagina 29
DMX 512 communicatie	
Enkele PLP-REM-350 unit.....	Pagina 30
Installatie met meerdere PLP-REM-350's.....	Pagina 31
RS-485 communicatie	
Enkele PLP-REM-350 unit.....	Pagina 32
RS-485 commando's.....	Pagina 33
RESET procedure.....	Pagina 34
Afstandsbediening batterij.....	Pagina 34
Probleemoplossing.....	Pagina 35
Kabelinstructies.....	Pagina 36
Kablering opmerking.....	Pagina 38

DURALINK

Technische specificaties

Algemene specificaties

Ingangsspanning:	230 VAC 50Hz
Uitgangsspanning:	12,5 VAC
Transformator vermogen:	350VA
Max uitgangsvermogen:	350 VA (12 VAC / 25A)
Max stroom relais contact A & B	16A / 250 VAC
Max schakel vermogen A & B	4000VA
RF band	868 MHz
Omgevingstemperatuur:	0°C to +40°C
Vochtigheidsgraad:	10% to 90% RH - non condensing
IP code:	IP54
IEC beschermingsklasse:	Class II 

PLP-REM-350 overzicht

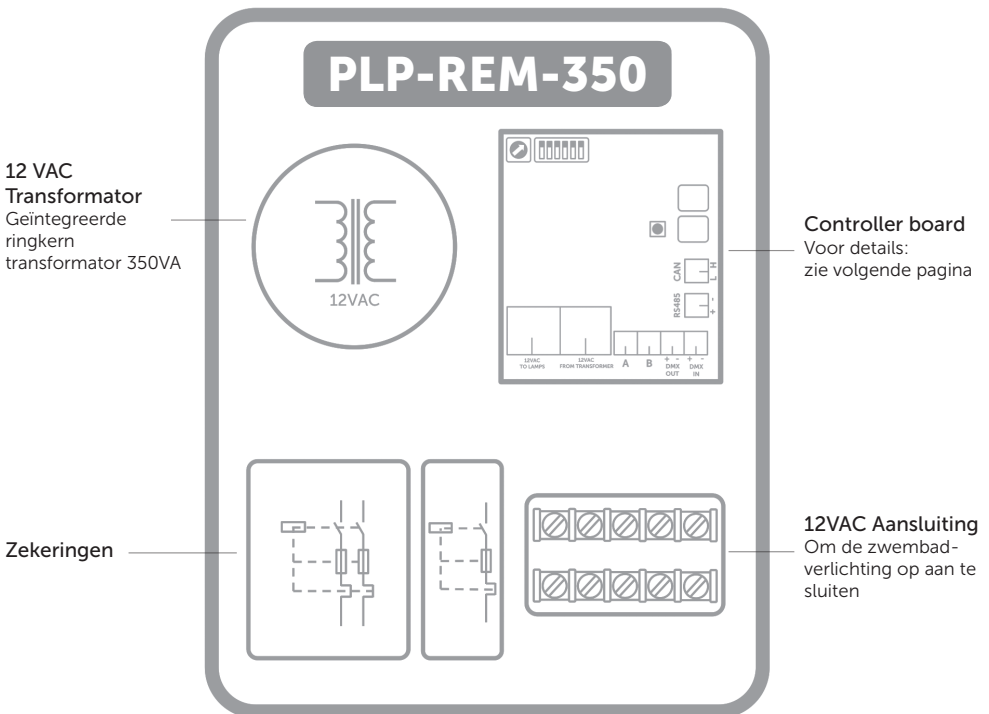

Controller bord

DMX adres toewijzer
Om het DMX start adres te kiezen

DIP schakelaar
Om de controller functies te selecteren

DuraLink RF board
Voor draadloze communicatie

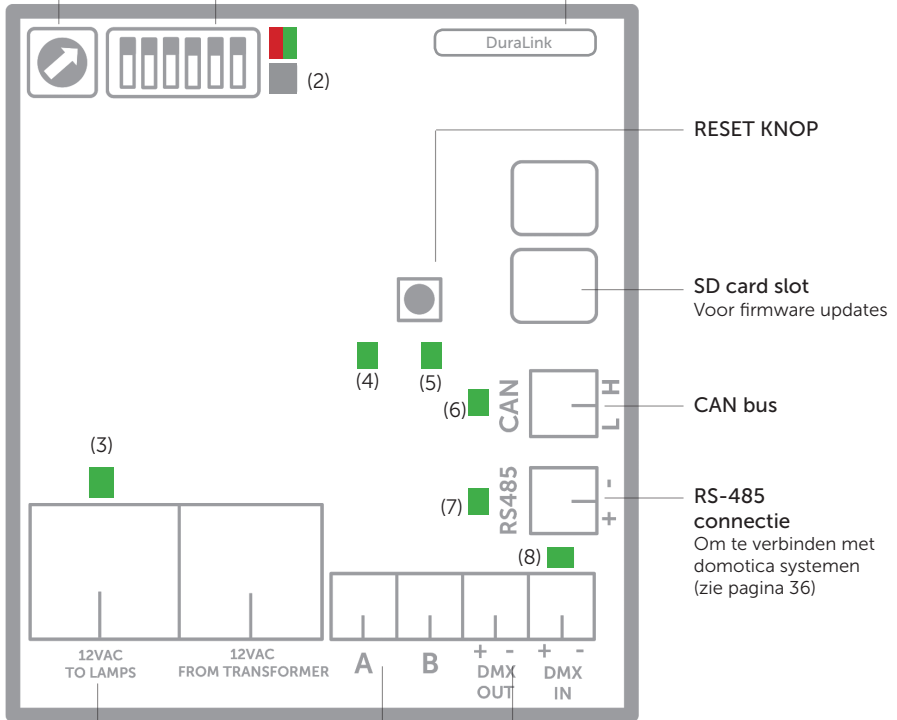

12VAC aansluitklemmen
Om de zwembadverlichting op aan te sluiten

A/B uitgang
Voor additionele circuits. Gedraagt zich als een SPST (single-pole, single-throw) schakelcontact

DMX ingang/uitgang
De PLP-REM kan werken als DMX ontvanger (met DMX doorgang-sig-naal)

Status LED's:

- (1) Algemene status
Groen = OK
Rood = overvoltage of overcurrent
- (2) RESET status
- (3) 12VAC naar zwembadverlichting
(Groen = AAN)
- (4) Schakelcontact A (Groen = AAN)

- (5) Schakelcontact B status
(Groen = AAN)
- (6) CAN status
- (7) RS-485 signaal
- (8) DMX signaal

Installatie instructies

Enkele PLP-REM-350 unit

- Verbind de 230VAC aansluiting van de PLA-REM-350 met de netspanning. Verbind de zwembadverlichting met de 12VAC aansluiting van de PLP-REM-350.
- The PLP-REM-350 heeft een ingebouwde 350VA transformator. Het totale vermogen van de zwembadverlichting (+kabel verliezen) mag dit niet overschrijden.



Kijk in de handleiding van het gekozen type zwembadverlichting om te weten hoeveel VA elke lamp nodig heeft.

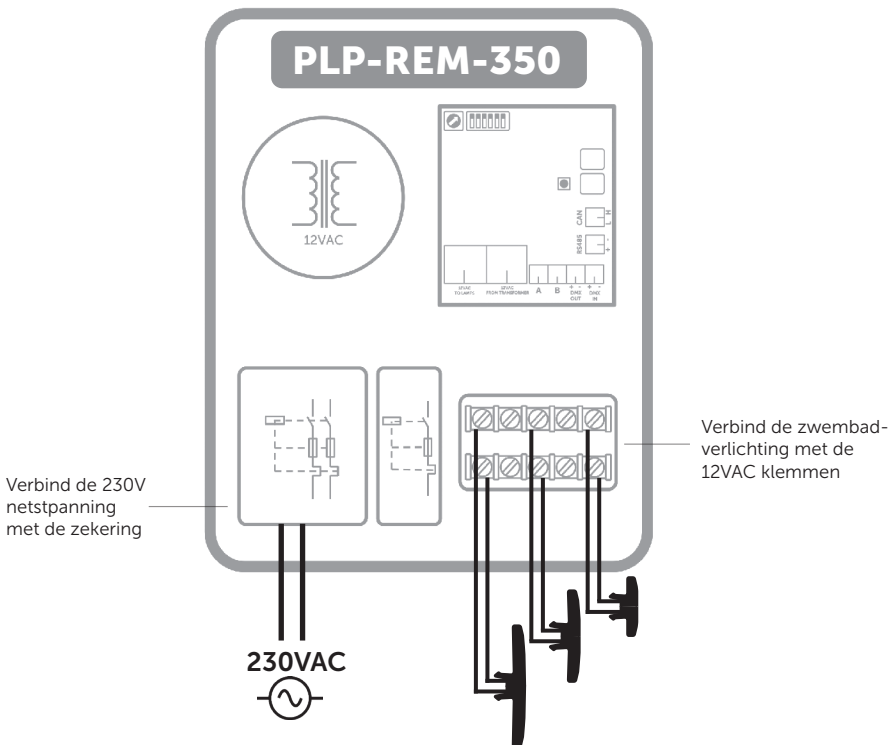

Installatie met meerdere PLP-REM-350's

Voor uitgebreide installaties (totale vermogen van de lampen > 350VA) kunnen meerdere PLP-REM-350's met elkaar verbonden worden. Op deze manier blijft een perfecte synchronisatie van alle lampen gegarandeerd.

De PLP-REM-350's moeten met elkaar kunnen communiceren, om zeker te zijn dat alle lampen synchroon kunnen lopen.

Verbind de PLP-REM-350's met elkaar via de CAN bus:

Verbind de CAN klemmen van de eerste PLP-REM-350 met de CAN klemmen van de tweede PLP-REM-350, verbind dan de tweede met de derde, enzovoort... (zie tekening onder)*

Respecteer de polariteit van de aansluitklemmen! (CAN L & H)

Vervolgens moeten de DIP switches van de PLP-REM-350's op de correcte positie (MASTER/SLAVE) gezet worden. De eerste PLP-REM-350 is de Master. Alle anderen zijn Slaves. Zie pagina 29 voor Master/Slave DIP switch info.



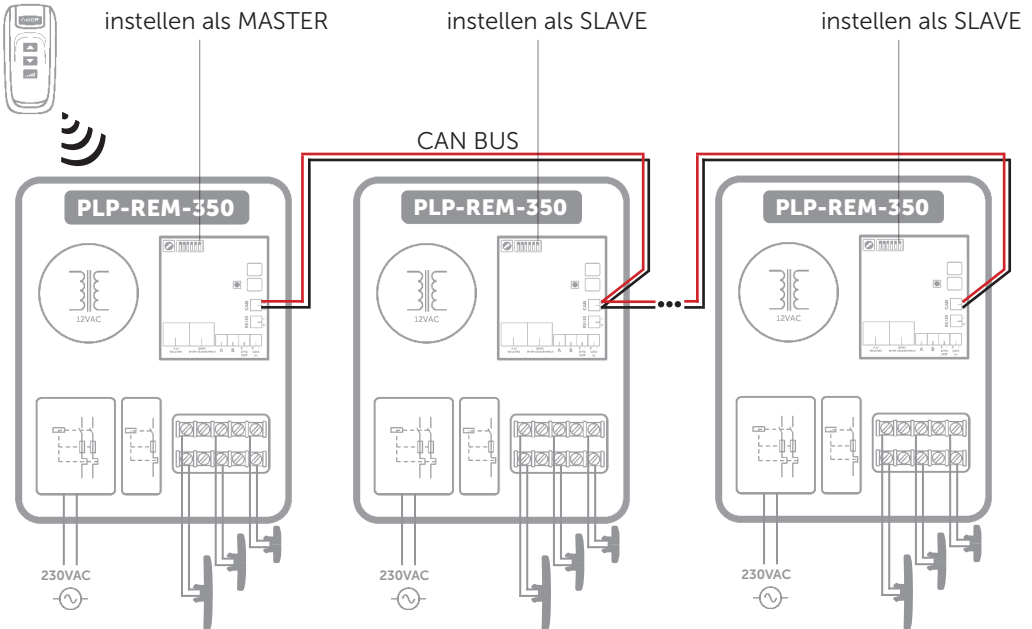







 In een Master/Slave opstelling reageert enkel de PLP-REM-350 die ingesteld is als MASTER op de commando's van de afstandsbediening. Eventuele extra zenders moeten dus worden gekoppeld aan deze MASTER PLP-REM-350

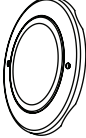
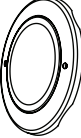

* We raden aan om een 'shielded twisted pair' kabel te gebruiken (min. 0,5mm² - tot 200m) om verschillende PLP-REM-350's te verbinden via de CAN bus.

Werkingsmodus

De PLP-REM-350 kan gebruikt worden in 2 hoofd werkingsmodi: "AAN/UIT bedieningsmodus" & "PLC bedieningsmodus". Elke modus heeft een aantal specifieke functies:

	AAN/UIT	PLC
Compatibele lampen	 VISION Adagio Pro	 VISION Adagio Pro  VISION Pro
	 VISION Spectra	
	 VISION Moonlight	
schakel lampen AAN/UIT	JA	JA
Verander kleur van lamp	JA ⁽¹⁾	JA ⁽¹⁾
Bedien Relais A & B	JA	JA
Dimmen van de lampen	NEE	JA ⁽¹⁾
DMX sturing	NEE	JA
RS-485 sturing	JA ⁽²⁾	JA
Dip switch positie	DIP 1 AAN	DIP 1 UIT
Type klavier afstandsbediening ⁽³⁾	   	   

1) Enkel voor RGB lampen

2) In AAN/UIT bedieningsmodus zijn slechts enkele RS-485 commando's beschikbaar (zie p 33)

3) Afhankelijk van de gekozen werkingsmodus, moeten de rubber toetsen van de afstandsbediening verwisseld worden (meegeleverd in verpakking).

DIP switch functies

De DIP switch op het moederbord van de PLP-REM-350 laat toe om een aantal functies van de PLP-REM-350 aan te passen:



WAARSCHUWING: Zorg ervoor dat de voedingsspanning van de PLP-REM-350 uitgeschakeld is, vooraleer de DIP switches te veranderen

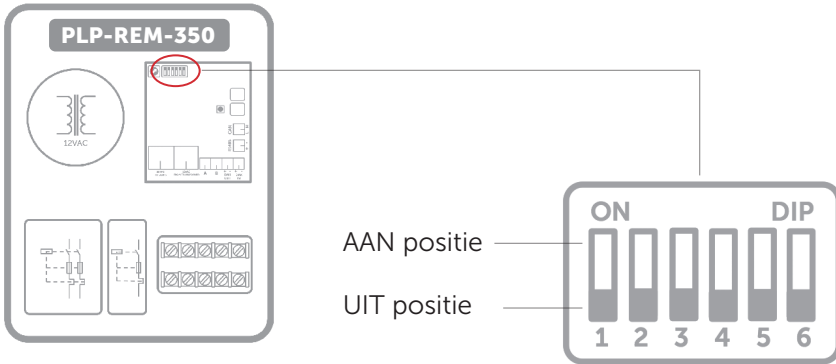

functie	setting	DIP SWITCH					
		1	2	3	4	5	6
Werkingsmodus	AAN/UIT	AAN					
	PLC	UIT					
Relais A	PULS modus		AAN				
	TOGGLE modus		UIT				
Relais B	PULS modus			AAN			
	TOGGLE modus			UIT			
SNELLE DMX instelling *	SNEL				AAN		
	STANDAARD				UIT		
DMX	GEEN LOOP					AAN	
	LOOP					UIT	
MASTER/SLAVE modus	SLAVE						AAN
	MASTER						UIT

* Snelle DMX instelling
Enkel voor Adagio Pro lampen vanaf 2018 en later

Afstandsbediening functies

WERKINGSMODUS: PLC (standaard modus)

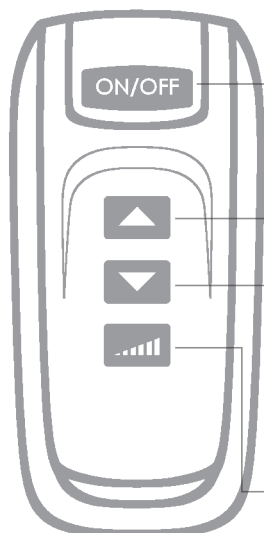

Kort drukken (< 1 sec):
Zet de lampen AAN of UIT⁽¹⁾

Lang drukken (> 2 sec⁽²⁾):
Zet alle lampen & de "12VAC TO LAMPS" relais UIT⁽¹⁾

Kort drukken:
Ga naar het volgende kleurprogramma

Lang drukken:
Zet de uitgang A AAN/UIT

Kort drukken:
Ga naar het vorige kleurprogramma

Lang drukken:
Zet de uitgang B AAN/UIT

Kort drukken:
Selecteer het volgende dim niveau:
100% -- 50% -- 25% ---> 100% -- ...

Lang drukken:
Zet de lampen op programma 1 (blauw) met
100% dim niveau (max helderheid)

WERKINGSMODUS: AAN/UIT

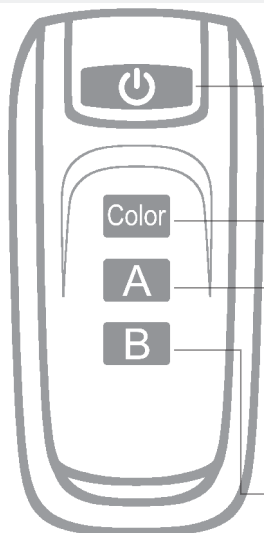

Kort drukken (< 1 sec):
Zet de lampen AAN of UIT⁽¹⁾

Kort drukken:
Ga naar het volgende kleurprogramma

Lang drukken:
Automatische sync procedure⁽³⁾

Kort drukken:
Zet de uitgang A AAN/UIT

Lang drukken:
/

Kort drukken:
Zet de uitgang B AAN/UIT

Lang drukken:
/

- (1) De laatste status van de lampen (AAN of UIT) wordt onthouden bij een stroomonderbreking
- (2) De groene LED in de afstandsbediening licht op zodra je een knop indrukt, en gaat uit na 2 seconden zodat je exact weet wanneer je de knop mag loslaten.
- (3) De lampen worden eerst UIT gezet gedurende 30 seconden en daarna 3x AAN/UIT gezet. De lampen worden hierdoor gesynchroniseerd en komen op kleurprogramma 1 te staan (blauw).

Klavier van afstandsbediening vervangen

Afhankelijk van de gekozen werkingsmodus, kan het klavier van de afstandsbediening vervangen worden:

- Verwijder de kruis schroef en open de afstandsbediening
- Vervang het klavier van de afstandsbediening
- Monteer het geheel terug in omgekeerde volgorde

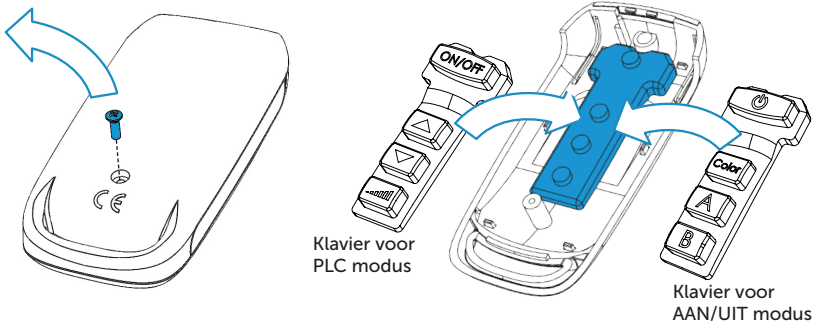

Afstandsbediening en controller koppelen

De afstandsbediening is reeds gekoppeld van in de fabriek. In probleemgevallen kan men de afstandsbediening ook manueel koppelen:

- 1) Druk op de "koppel knop" binnenin de PLP-REM-350
---> De BLAUWE LED begint te knipperen.
- 2) Druk op eender welke knop van de afstandsbediening binnen de 25sec.
---> Als de afstandsbediening correct is gekoppeld, knippert de BLUE LED 5 keer langzaam
---> **ONTKOPPELEN:**
Zie RESET procedure: pagina 34

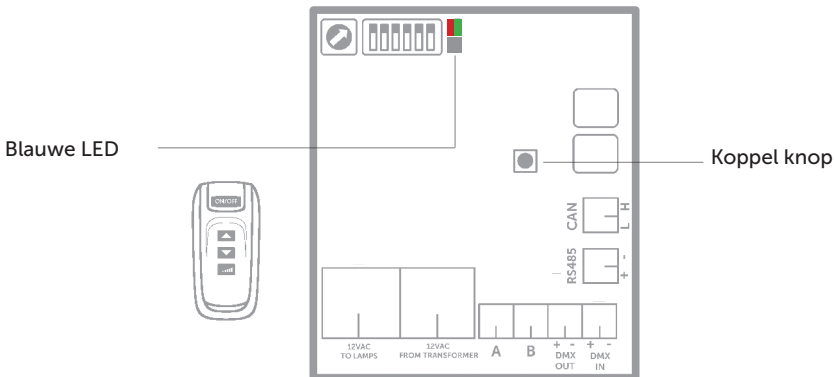

DMX 512 communicatie

Enkele PLP-REM-350 unit

- 1) Zorg ervoor dat DIP schakelaar 1 is uitgeschakeld.
- 2) Zorg ervoor dat de lampen aan staan via de afstandsbediening.

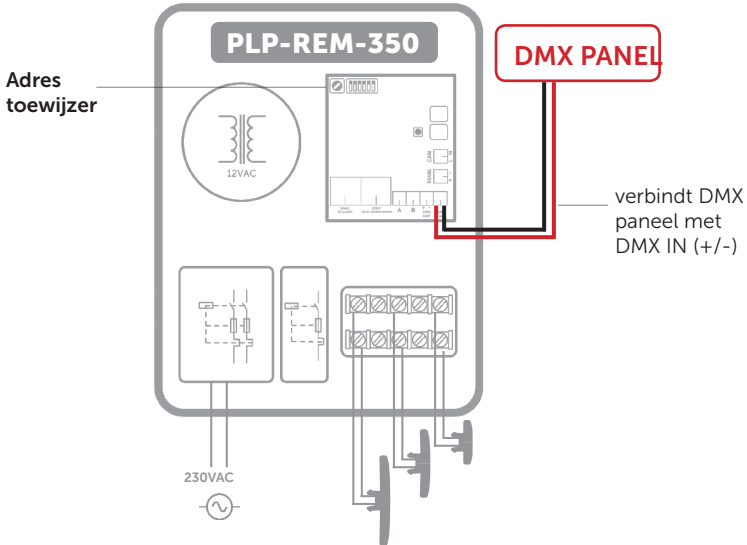

Adres toewijzer instelling

DMX adres van de PLP-REM-350 instellen:

Kies een positie van de adres toewijzer. Het gekozen cijfer bepaalt de DMX adressen van de PLP-REM-350 & lampen.

Elke lamp gebruikt 3 bytes DMX data (R-G-B) en alle lampen ontvangen dezelfde DMX data van de PLP-REM-350.

Adres toewijzer positie	0			1			2			...
	R	G	B	R	G	B	R	G	B	...
DMX adres	1	2	3	4	5	6	7	8	9	...

Het DMX start adres kan overschreven worden, door het RS-485 commando "set DMX start address" te gebruiken (zie pagina 33).

! Opmerking:

In DMX512 bedrijf, kan de je met de afstandsbediening nog steeds één van de drie dim niveaus selecteren en nog steeds de lampen schakelen. Dit kan niet verworpen worden door DMX512 gegevens

Installatie met meerdere PLP-REM-350's

- 1) Verbindt het DMX paneel met de "DMX IN" poort van de eerste PLP-REM-350
- 2) Verbindt de PLP-REM-350's met elkaar zoals op onderstaande foto
DMX OUT --> DMX IN (gepolariseerde aansluiting + -)
- 3) Stel het DMX adres in voor elke PLP-REM-350 via de adres toewijzer.
 - Optie 1: Alle PLP-REM-350's zitten op hetzelfde adres:
Dit zorgt ervoor dat alle lampen dezelfde DMX data ontvangen, en zich allemaal identiek gedragen.
 - Optie 2: De PLP-REM-350's zitten op verschillende adressen:
Elke PLP-REM-350 heeft zijn eigen "groep" lampen die zich onderling identiek gedragen.
En elke PLP-REM-350 kan dan nog eens afzonderlijk aangestuurd worden.

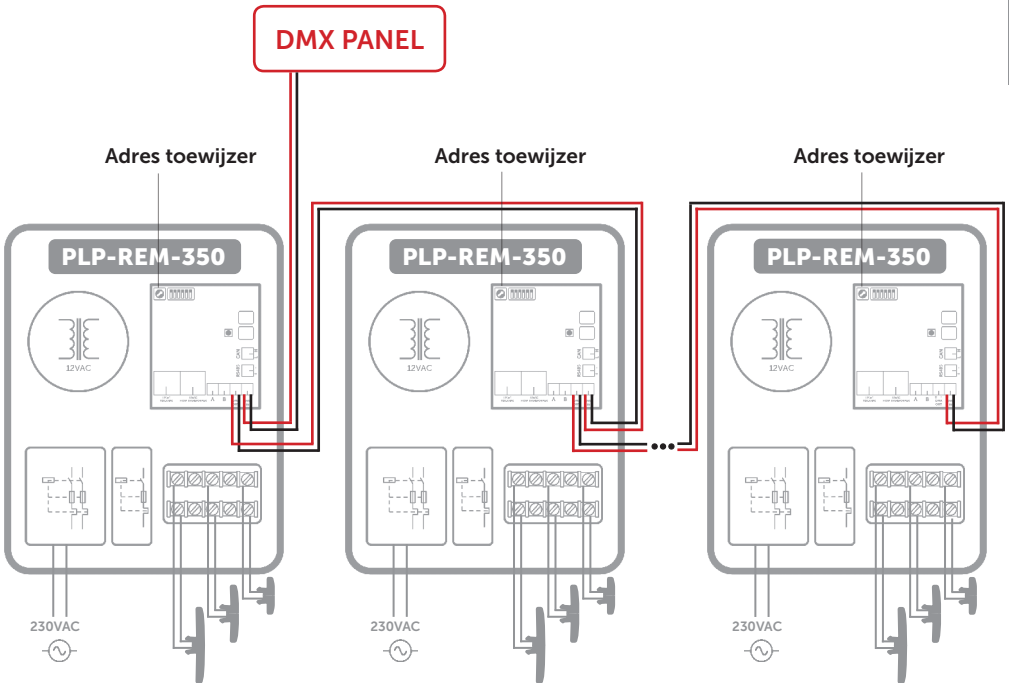

RS-485 communicatie

Enkele PLP-REM-350 unit

- 1) Zorg ervoor dat DIP schakelaar 1 is uitgeschakeld.
- 2) Zorg ervoor dat de lampen aan staan via de afstandsbediening.
- 3) Verbindt de RS-485 bron met de "485" poort op de PLP-REM-350
- 4) Communicatie instellingen: 9600, 8, 1, n
- 5) Commando lijst: zie pagina 33

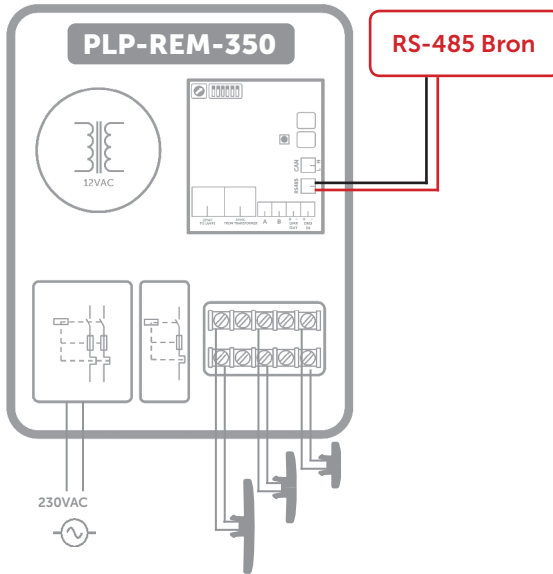

Installatie met meerdere PLP-REM-350's

- 1) Verbindt de PLP-REM-350's met elkaar via de CAN bus (zie pagina 27)
- 2) Zorg ervoor dat DIP schakelaar 1 is uitgeschakeld
- 3) Zorg ervoor dat de lampen aan staan via de afstandsbediening
- 4) Verbindt de eerste PLP-REM-350 met de RS-485 bron zoals hierboven beschreven. Deze PLP-REM-350 is de Master.
- 5) Communicatie instellingen en commando lijst: zie boven

RS-485 Commando's

Command	Command	Remark	Example	available in ON/OFF mode	available in PLC mode
Lamps OFF	PL0	All lamps OFF		X	X
Lamps ON	PL1	All lamps ON		X	X
Program UP	PsU	Jump to next program		X	X
Program Down	PsD	Return to previous program			X
Set Program	PSxx	xx is the decimal representation of the program number (01 - 14)	PS06 = jump to program 6		X
Auto sync procedure	PsS	executes the auto sync procedure (see pagina 10)		X	X
White 1	PW1	Jump to White 1 (program 12)			X
White 2	PW2	Jump to White 2 (program 13)			X
White 3	PW3	Jump to White 3 (program 14)			X
Set RGB	PCrrrgggbbb	rrr, ggg and bbb are the decimal representation of the RGB value (with leading zero's)	1) PC255128064 = Full output level on Red color, half output level on Green color, 1/4 output level on Blue color 2) PC252525255 = All colors at full output level 3) PC000000000 = All colors OFF		X
Set Dim value	PDxxx	set the OUTPUT value of the lamp in % (000 - 100)	PD075 = 75% output level (on all LED's)		X
set DMX startAddress	PAxxxxyz	y = 'e' or 'E'	PA035E = set DMX start address to 35 [35(R), 36(G), 37(B)]		X
Set color in percentage	Pprgbe	variable size, rgb = ASCII 0-255, e = end character	Pp25050100e = Red 25%, Green 50%, Blue 100%		X
Set color in hex	Pcrgbe	variable size, rgb = ASCII 0-255, e = end character	Pc64128255e = Red 25%, Green 50%, Blue 100%		X
Relay A control	PRAx	x = 1 (ON), 0 (OFF), P (Pulse) this overrides dipswitch	PRA1 = Relay A ON PRA0 = Relay A OFF	X	X
Relay B control	PRBx	x = 1 (ON), 0 (OFF), P (Pulse) this overrides dipswitch	PRB1 = Relay B ON PRB0 = Relay B OFF	X	X
ON/OFF relay control	PRMx	x = 1 (ON), 0 (OFF)	PRM1 = Relay ON/OFF control ON	X	X
Color temperature	PTxyz	x = ten thousand ; y = thousand ; z = hundred	PT035 = Set white color temperature to 3500K (in steps of 500K)		X

RESET procedure

RESET procedure voor het controller bord

- 1) Zorg ervoor dat de PLP-REM-350 AAN staat.
- 2) Druk op de RESET knop op het controller board.
- 3) De blauwe LED gaat branden
- 4) Laat de RESET knop los van zodra de blauwe LED uitgaat

 *Het controller board is nu ge-RESET.
Alle afstandsbedieningen zijn nu ontkoppeld.*

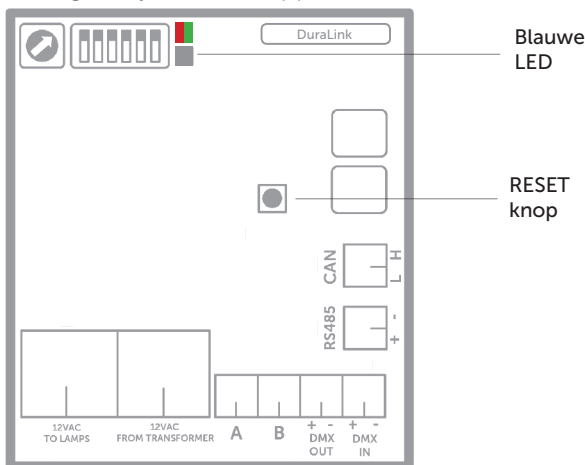

Afstandsbediening batterij

Batterij vervangen:

- Verwijder de kruiskop schroef en open de afstandsbediening
- Vervang de batterij en respecteer de polariteit.

Batterij type: A23 12V

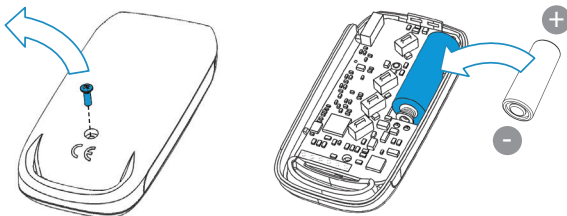

Probleemoplossing

PROBLEEM

De PLP-REM-350 reageert niet op commando's van de afstandsbediening

OPLOSSING

- Voer een RESET procedure uit
- Controleer de batterij van de afstandsbediening (zie pagina 34)
- De afstandsbediening is niet correct gekoppeld met de controller. Herhaal de koppel procedure (zie pagina 32)
- Verminder de afstand tussen de afstandsbediening en de controller en/of verwijder obstakels
- Controleer de algemene status LED op het controller board. Als deze rood is dan is de secundaire spanning te hoog (>14VAC) of er is een kortsluiting.
- Controleer de LED op de kleine DURALINK printplaat (rechter bovenhoek). Deze LED moet knippen, elke keer er op een knop van de afstandsbediening gedrukt wordt. Als de LED werkt, is er mogelijk een probleem met het controller board

De zwembadverlichting werkt niet

- Voer een RESET procedure uit
- Verifieer of alle verbindingen gemaakt zijn zoals op de elektrische schema's
- Zet de PLP-REM-350 in AAN/UIT mode (DIP switch nr 1) en controleer of de lampen werken

De afstandsbediening werkt niet meer na een firmware update van de PLP-REM-350 voor LinkTouch compatibiliteit

- Koop een nieuwe TX868 afstandsbediening met geupdate firmware

Kabelinstructies



WARNING



- GB **Cable installation guidelines**
- NL **Richtlijnen voor bekabeling**
- DE **Anleitung zur Verkabelung**
- FR **Instructions de câblage**
- IT **Istruzioni di collegamento**
- ES **Instrucciones para ajuste del cableado**

Please refer to the manual of your DURAVISION® pool light



Manual downloads:
www.duratech.be/downloads

Not following the instructions for cable cross section and transformer VA ratings may result in lamp malfunctioning and may result in having to rewire the installation. The manufacturer's warranty does not apply in this situation.

Voor gedetailleerde informatie in verband met kabelsecties en maximum lengtes verwijzen we graag naar de handleiding van uw DURAVISION zwembadlamp.

Kablering opmerkingen

1. Andere toestellen zoals frequentie inverters of elektrische motors kunnen veel ruis veroorzaken op de 230VAC / 400VAC spanningslijn. Het is mogelijk dat dit ruis geïnjecteerd wordt in een nabijgelegen 12VAC kabel, en dusdanig de communicatie naar de zwembadlampen verstoord.



Houdt 230VAC / 400VAC voedingskabels uit de buurt van de 12VAC kabels van de lampen. De minimum afstand bedraagt 50cm, en dit over de gehele lengte van de kabel



Zorg ervoor dat er geen 12VAC en 230VAC / 400VAC kabels samen in eenzelfde kabelgoot liggen

2. Stroomloze aders in een meeraderige kabel zijn niet toegestaan omdat dit de PLC communicatie verstoort



We raden aan om 2-aderige kabels te gebruiken voor alle Adagio Pro lampen om PLC communicatie problemen te vermijden

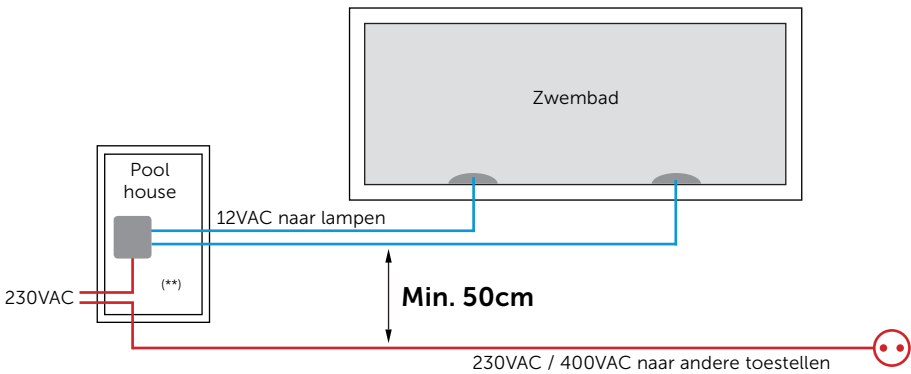

(**) Zorg ervoor dat er geen 12VAC en 230VAC / 400VAC kabels samen in eenzelfde kabelgoot liggen

Sommaire

Spécifications techniques	
Spécifications générales.....	Page 40
Aperçu du PLP-REM-350.....	Page 40
Circuit imprimé.....	Page 41
Instructions d'installation	
Installation d'un seul appareil PLP-REM-350.....	Page 42
Installation de plusieurs appareils PLP-REM-350.....	Page 43
Modes de fonctionnement.....	Page 44
Fonctions du commutateur DIP.....	Page 45
Fonctions de la télécommande	
Mode de fonctionnement: PLC.....	Page 46
Mode de fonctionnement: ON/OFF.....	Page 46
Remplacer le clavier de la télécommande.....	Page 47
Appairer la télécommande portable.....	Page 47
Communication via DMX 512	
Avec un seul appareil PLP-REM-350.....	Page 48
Avec plusieurs appareils PLP-REM-350.....	Page 49
Communication via RS-485	
Avec un seul appareil PLP-REM-350.....	Page 50
Jeu d'instructions pour RS-485.....	Page 51
Procédure de réinitialisation.....	Page 52
Pile de la télécommande.....	Page 52
Résolution des problèmes.....	Page 53
Instructions de câblage de la piscine.....	Page 54
Instructions de câblage - remarque.....	Page 56

DURALINK

Spécifications techniques

Spécifications générales

Tension d'entrée:	230 VAC 50Hz
Tension de sortie:	12,5 VAC
Puissance du transformateur:	350VA
Puissance de sortie maximale:	350 VA (12 VAC / 25A)
Valeurs maximales des contacts de relais A & B:	16A / 250 VAC
Puissance de commutation maximale A & B:	4000VA
Bande RF	868 MHz
Température ambiante:	0°C to +40°C
Humidité:	10 % à 90 % HR - sans condensation
Indice de protection:	IP54
Classe de Protection IEC:	Class II 

Aperçu du PLP-REM-350

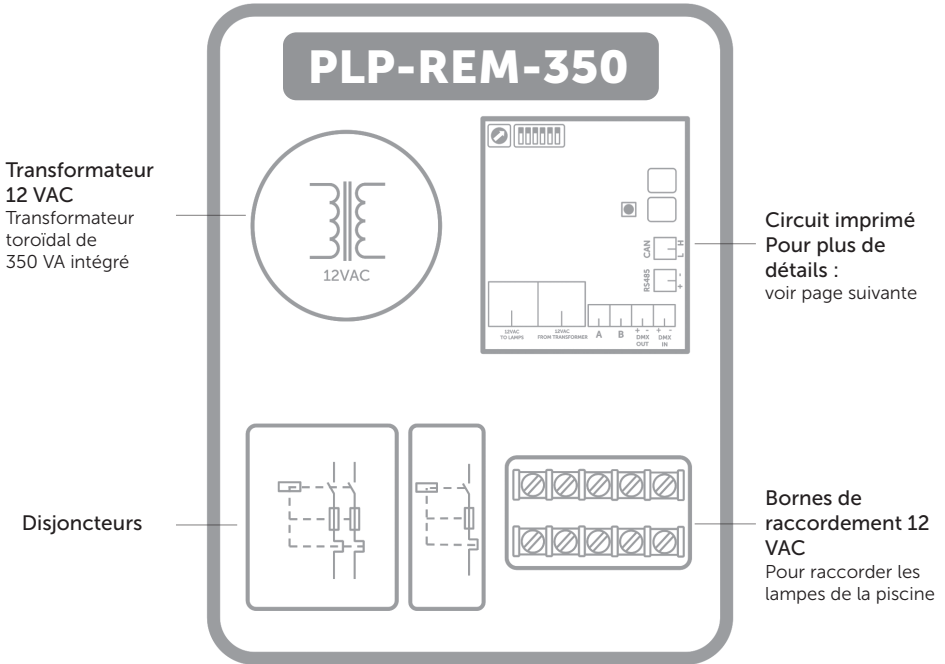

Circuit imprimé

Molette d'adresse DMX
Pour sélectionner
l'adresse de départ du DMX

Commutateur DIP
Pour sélectionner les fonctions du
contrôleur

Circuit Imprimé DuraLink RF
Pour communication sans fil

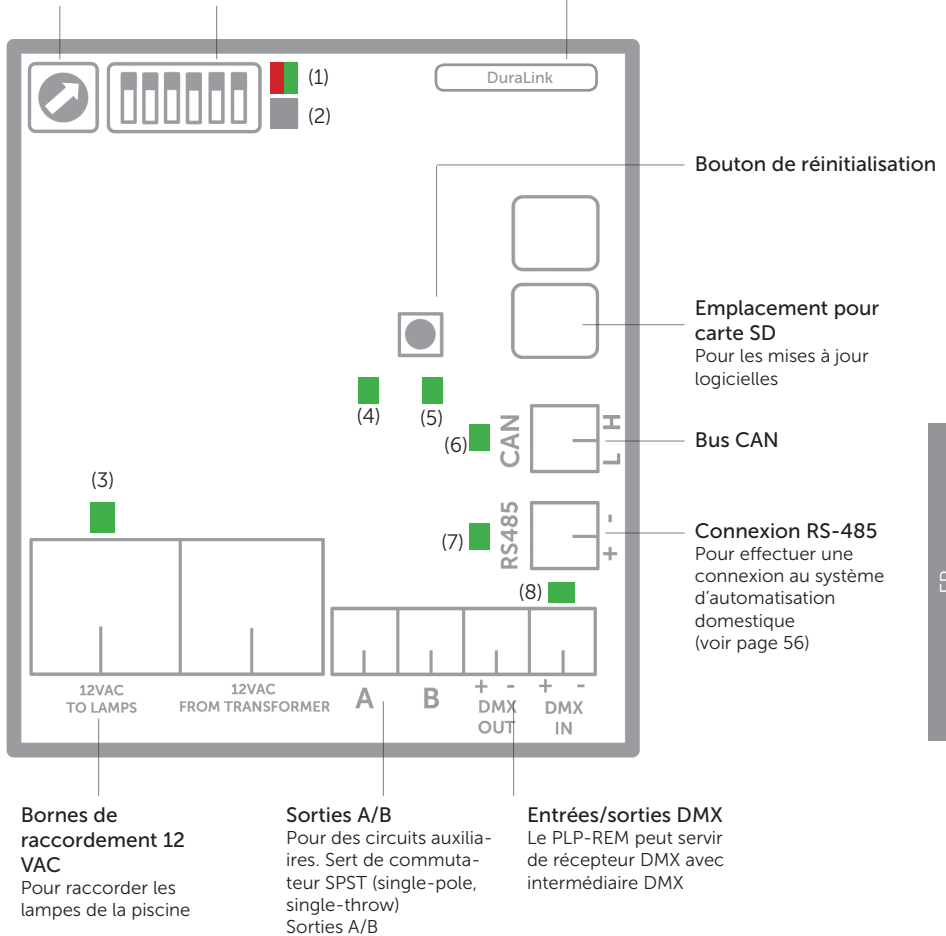

Témoins LED :

- | | |
|---|--------------------------------------|
| (1) État général
Vert = OK
Rouge = Erreur surtension où court-circuit | (5) Commutateur B
(VERT = allumé) |
| (2) RÉINITIALISATION | (6) État CAN |
| (3) 12 VAC vers les lampes de la piscine
(VERT = allumé) | (7) Signal RS-485 |
| (4) Commutateur A (VERT = allumé) | (8) Signal DMX |

Instructions d'installation

Installation d'un seul appareil PLP-REM-350

- Raccordez une alimentation de 230 VAC aux bornes 230 VAC du PLP-REM-350. Raccordez les lampes de la piscine au bornier de raccordement 12 VAC dans le PLP-REM-350.
- Le PLP-REM-350 intègre un transformateur de 350 VA. La puissance totale des lampes (+ pertes de câbles) de la piscine ne peut pas dépasser cette valeur.

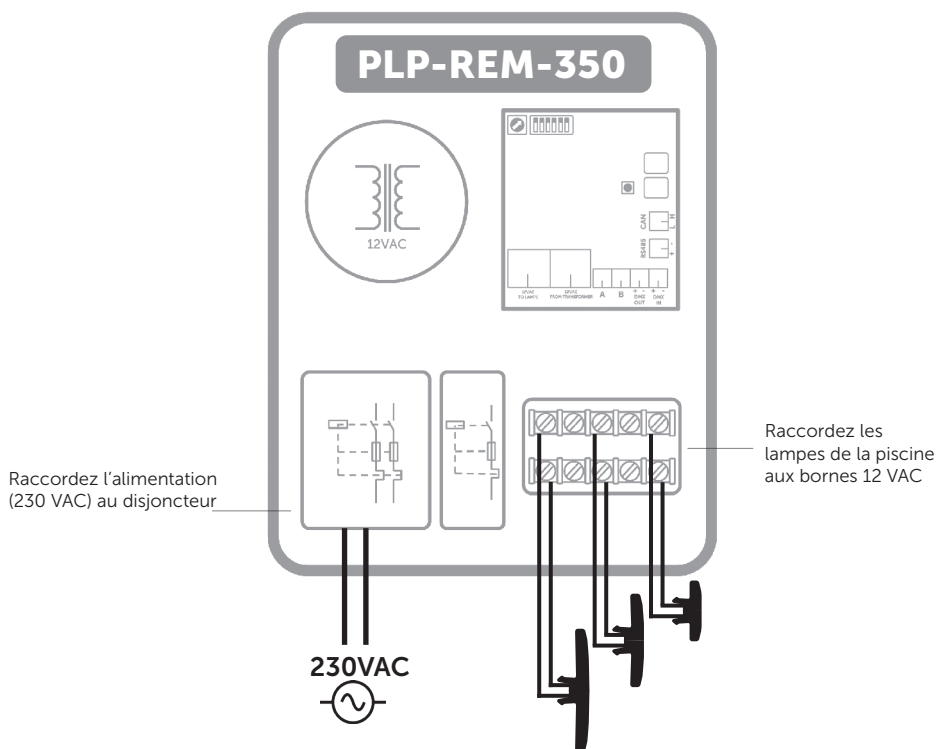

Installation de plusieurs appareils PLP-REM-350

Pour des installations plus grandes (puissance totale des lampes > 350 VA), plusieurs PLP-REM-350 peuvent être raccordés entre eux. Ainsi, une synchronisation parfaite de toutes les lampes de la piscine reste garantie

Les PLP-REM-350 doivent pouvoir communiquer entre eux, de manière à ce que toutes les lampes soient parfaitement synchronisées.

Raccordez les PLP-REM-350 entre eux via le bus CAN.

Raccordez les bornes CAN du premier PLP-REM-350 avec celles du second PLP-REM-350*

Si plus de 2 PLP-REM-350 sont nécessaires, raccordez simplement chaque borne CAN en parallèle avec celle du PLP-REM-350 suivant (voir ci-dessous). Veillez à respecter la polarité des bornes ! (CAN L & H)

Ensuite, réglez les commutateurs DIP des PLP-REM-350 sur le bon réglage MAÎTRE / ESCLAVE. Le premier PLP-REM-350 sera le maître. Tous les autres seront ESCLAVE. Reportez-vous à la page 49 pour les informations sur les commutateurs DIP Maître/Esclave.



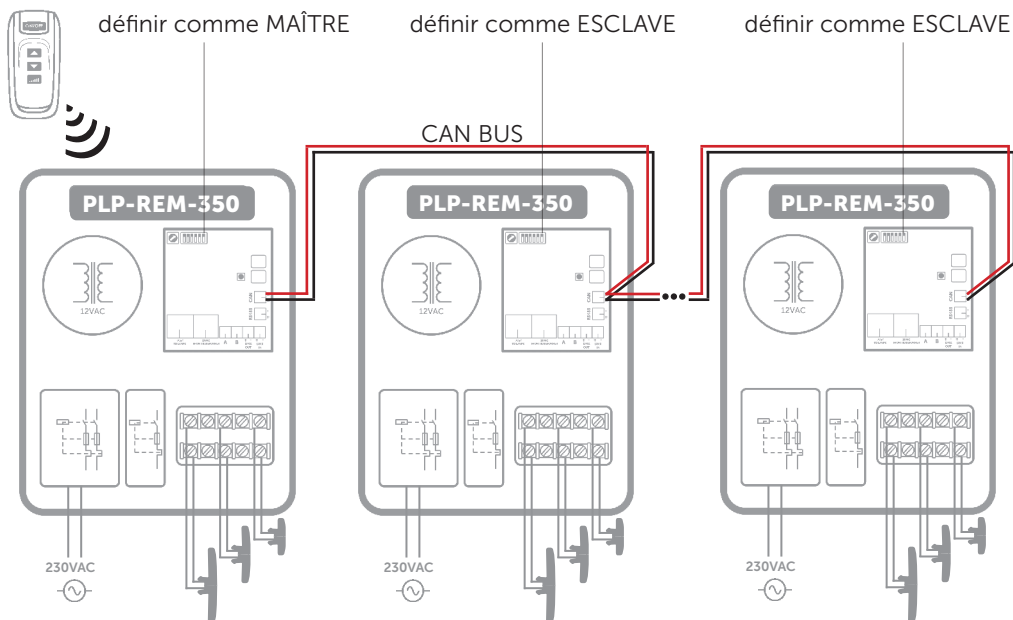









 Dans une configuration Maître/Esclave, seul le PLP-REM-350 défini comme MAÎTRE réagit aux commandes de la télécommande. Toutes les télécommandes supplémentaire devra être couplé avec ce MAÎTRE PLP-REM-350



* Nous vous recommandons d'utiliser un câble à paire torsadée blindée (min. 0,5 mm² - jusqu'à 200 m) pour la connexion plusieurs PLP-REM-350 utilisant le bus CAN.

Modes de fonctionnement

Le contrôleur PLP-REM-350 offre 2 modes de fonctionnement principaux : « Mode de fonctionnement ON/OFF » & « Mode de fonctionnement PLC ». Chaque mode offre ses propres fonctions :

	ON/OFF	PLC
Lampes compatibles	 VISION Adagio Pro  VISION Spectra  VISION Moonlight	 VISION Adagio Pro  VISION Pro
Allumer/éteindre les lampes	OUI	OUI
Changer la couleur de la lampe	OUI ⁽¹⁾	OUI ⁽¹⁾
Contrôler les relais A & B	OUI	OUI
Régler l'intensité des lampes	NON	OUI ⁽¹⁾
Contrôle DMX	NON	OUI
Contrôle RS-485	OUI ⁽²⁾	OUI
Configuration du commutateur DIP	DIP 1 ON	DIP 1 OFF
Type de clavier sur la télécommande ⁽³⁾	   	   

1) Uniquement pour les lampes RGB

2) En mode commande ON/OFF, seules quelques commandes RS-485 sont disponibles (voir page 51)

3) En fonction du mode de commande sélectionné, le clavier de la télécommande doit être changé

Fonctions du commutateur DIP

Le commutateur DIP intégré sur le circuit imprimé principal du PLP-REM-350 permet à l'utilisateur de personnaliser la manière dont le PLP-REM-350 fonctionne.

! ATTENTION: Toujours couper l'alimentation électrique principale PLP-REM-350 avant de changer les commutateurs DIP

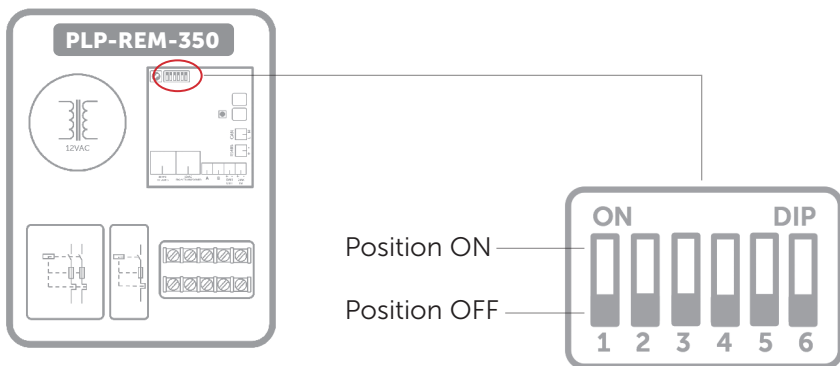

fonction	réglage	DIP SWITCH					
		1	2	3	4	5	6
Mode de fonctionnement	ON/OFF	ON					
	PLC	OFF					
Relais A	Mode PULSE		ON				
	Mode TOGGLE		OFF				
Relais B	Mode PULSE			ON			
	Mode TOGGLE			OFF			
DMX rapide *	RAPIDE				ON		
	STANDARD				OFF		
DMX	PAS DE BOUCLE					ON	
	BOUCLE					OFF	
Mode MAÎTRE/ESCLAVE	ESCLAVE						ON
	MAÎTRE						OFF

* DMX rapide
Seulement pour les lampes Adagio Pro à partir de 2018.

Fonctions de la télécommande

MODE DE FONCTIONNEMENT: PLC (mode par défaut)

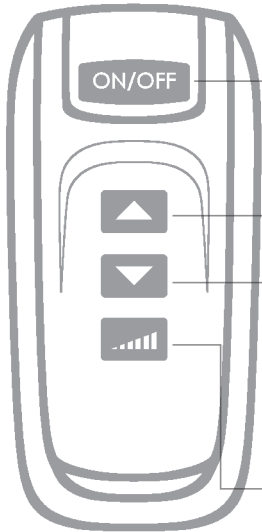

Appuyer brièvement (< 1 sec) :
Allumer ou éteindre les lampes ⁽¹⁾

Appuyer longuement (> 2 sec⁽²⁾) :
Toutes les lampes & le relais "12VAC TO LAMPS" sont éteints ⁽¹⁾

Appuyer brièvement:
Aller au programme de couleur suivant

Appuyer longuement:
Allumer/éteindre la sortie A

Appuyer brièvement:
Aller au programme de couleur précédent

Appuyer longuement:
Allumer/éteindre la sortie B

Appuyer brièvement:
Sélectionner le réglage d'intensité suivant:
100% -- 50% -- 25% ---> 100% -- ...

Appuyer longuement:
Réglage des lampes sur le Programme 1 (bleu) & intensité maximale

MODE DE FONCTIONNEMENT: ON/OFF

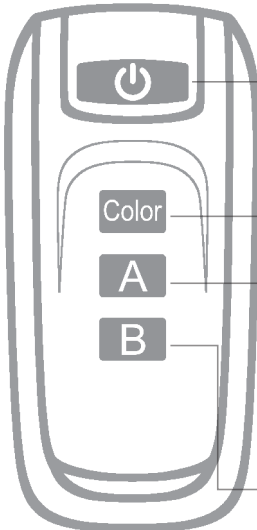

Appuyer brièvement(< 1 sec):
Allumer ou éteindre les lampes ⁽¹⁾

Appuyer brièvement:
Aller au programme de couleur suivant

Appuyer longuement:
Procédure de synchronisation automatique ⁽³⁾

Appuyer brièvement:
Allumer/éteindre la sortie A

Appuyer longuement:
/

Appuyer brièvement:
Allumer/éteindre la sortie B

Appuyer longuement:
/

(1) L'état des lampes (ON ou OFF) est mémorisé après la mise hors tension

(2) La LED verte de la télécommande s'allumera dès que vous appuierez sur un bouton et s'éteindra après 2 seconds, de façon à ce que vous sachiez exactement quand vous pouvez relâcher le bouton.

(3) Les lampes seront éteintes durant 30 secondes et ensuite allumées/éteintes 3 fois. Cela réglerà toutes les lampes sur le programme 1 : bleu

Remplacer le clavier de la télécommande (sélection du mode de commande)

En fonction du mode de commande sélectionné, le clavier de la télécommande doit être changé:

- Retirez la vis cruciforme et ouvrez la télécommande
- Remplacez le clavier dans la partie supérieure du boîtier de la télécommande
- Réassemblez en ordre inverse

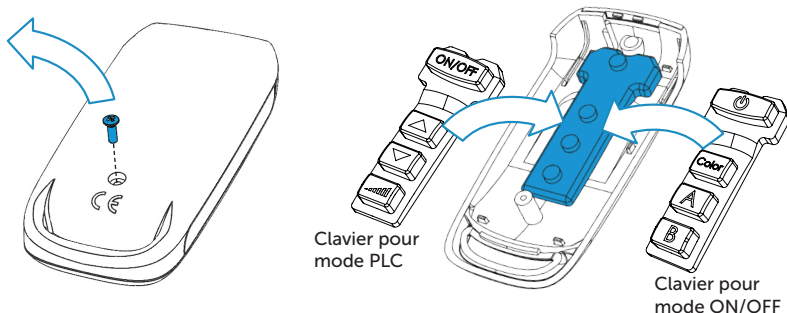

Appairer la télécommande portable au PLP-REM-350

Toutes les télécommandes portables sont appairées au préalable en usine et prêtes à être utilisées. Si un problème devait survenir, le processus d'appairage peut être réalisé comme suit :

- 1) Appuyez sur le bouton d'appairage sur le petit circuit imprimé à l'intérieur du PLP-REM-350.
---> La LED bleue va commencer à clignoter
- 2) Dans les 25 secondes qui suivent, appuyez sur n'importe quel bouton de la télécommande portable.
---> Si la télécommande est correctement appairée, la LED bleue clignotera lentement pendant 5 fois
---> *UNPAIRING*:
Voir la procédure RESET: page 52

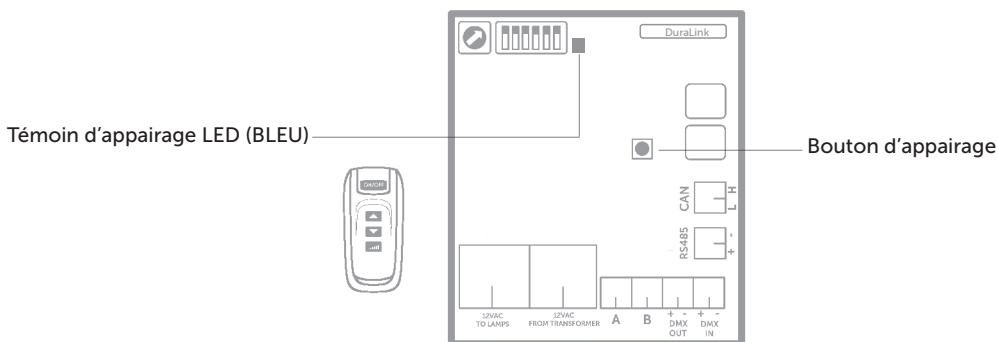

Communication via DMX 512

Avec un seul appareil PLP-REM-350

- 1) Assurez-vous que le commutateur DIP 1 est désactivé.
- 2) Assurez-vous que les lumières sont allumées en premier avec la télécommande.

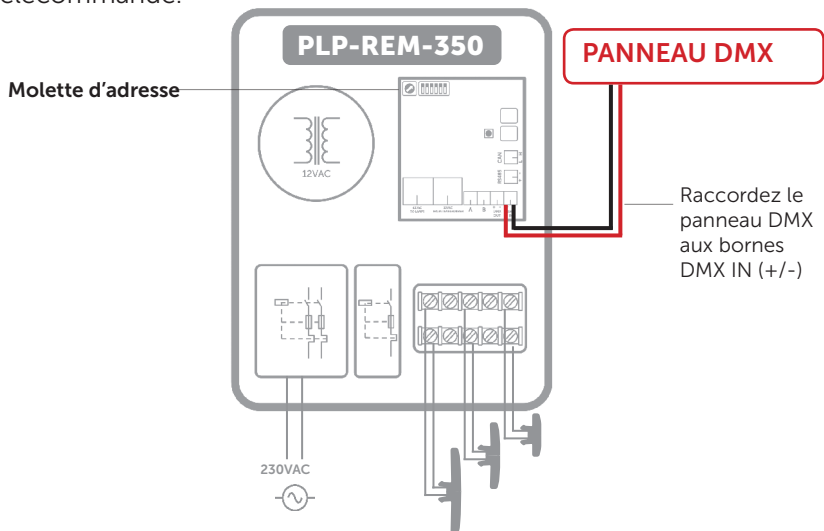

Réglage de la molette d'adresse

Définir l'adresse DMX du PLP-REM-350 :
Sélectionnez le chiffre désiré sur la molette d'adresse. Le chiffre choisi détermine les adresses DMX du PLP-REM-350 et des lampes. Chaque lampe utilise 3 octets de données DMX (R-G-B), et toutes les lampes reçoivent les mêmes données DMX depuis le PLP-REM-350.

Position de la molette d'adresse	0			1			2			...
	R	G	B	R	G	B	R	G	B	...
Adresse DMX	1	2	3	4	5	6	7	8	9	...

L'adresse DMX de départ peut être annulée en utilisant la commande RS-485 : "set DMX start address" (voir page 51)

! Remarque:

En fonctionnement DMX512, l'émetteur portable peut toujours sélectionner l'un des trois niveaux de gradation et peut toujours commuter les lampes. Cela ne peut pas être annulé par les données DMX512.

Avec plusieurs appareils PLP-REM-350

- 1) Raccordez le panneau DMX au port « DMX IN » du premier PLP-REM-350
- 2) Raccordez les PLP-REM-350 entre eux (boucle ouverte) : DMX OUT --> DMX IN (bornes polarisées + -)

- 3) Définissez l'adresse DMX pour chaque PLP-REM-350 via la molette d'adresse.

- Option 1: Tous les PLP-REM-350 peuvent être réglés sur la même adresse:

Cela implique que toutes les lampes recevront les mêmes données DMX, et qu'elles fonctionneront toutes de la même manière

- Option 2: Il est possible d'attribuer des adresses différentes aux PLP-REM-350:

Chaque PLP-REM-350 aura son propre groupe de lampes raccordées qui fonctionneront de manière identique. Cela étant, vu que chaque PLP-REM-350 a sa propre adresse unique, les différents groupes de lampes peuvent être contrôlés séparément

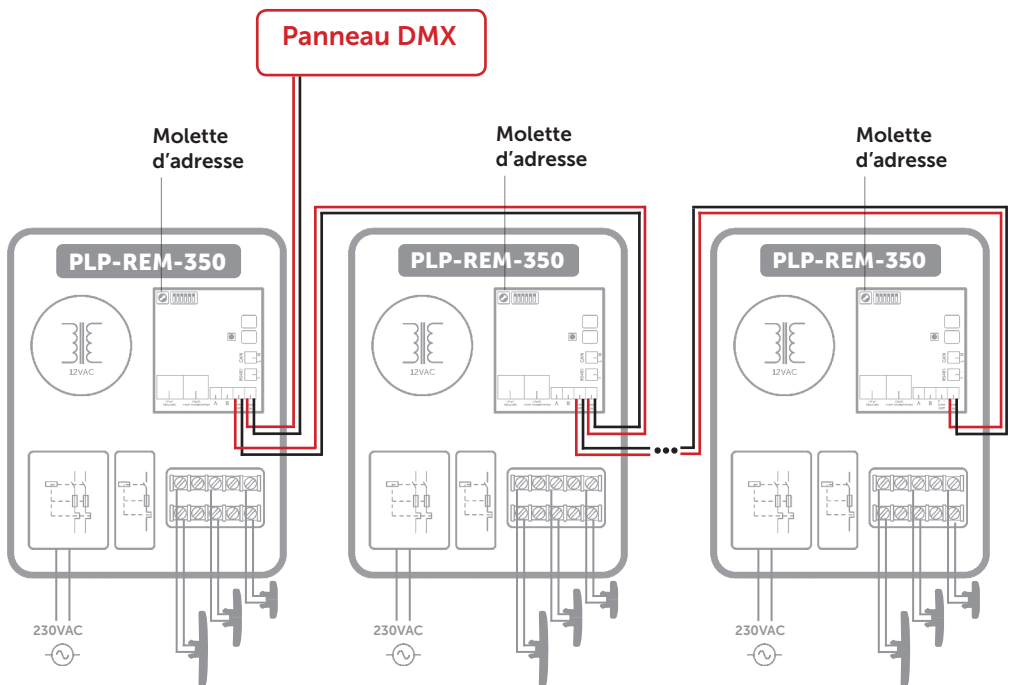

Communication via RS-485

Avec un seul appareil PLP-REM-350

- 1) Assurez-vous que le commutateur DIP 1 est désactivé.
- 2) Assurez-vous que les lumières sont allumées en premier avec la télécommande.
- 3) Raccordez la source RS-485 au port "485" sur le PLP-REM-350
- 4) Paramètres de communication: 9600, 8, 1, n
- 5) Liste de commandes: voir page 51

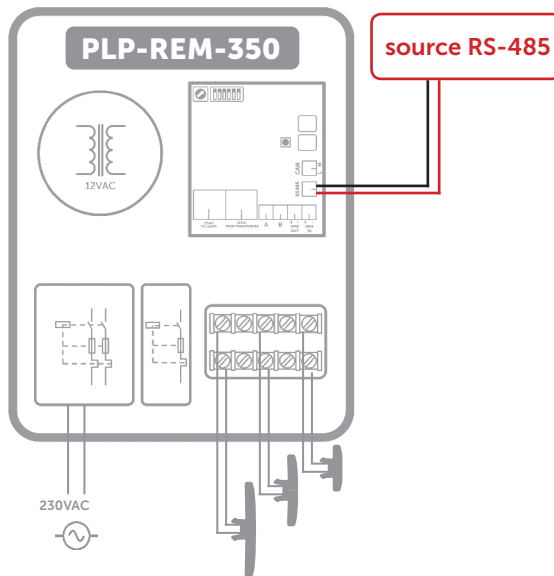

Avec plusieurs appareils PLP-REM-350

- 1) Connectez les PLP-REM-350 entre eux via le bus CAN (voir page 47)
- 2) Assurez-vous que le commutateur DIP 1 est désactivé
- 3) Assurez-vous que les lumières sont allumées via la télécommande
- 4) Connectez le premier PLP-REM-350 à la source RS-485 comme ci-dessus décrit. Ce PLP-REM-350 est le maître.
- 5) Paramètres de communication et liste de commandes: voir ci-dessus

RS-485 Command set

Command	Command	Remark	Example	available in ON/OFF mode	available in PLC mode
Lamps OFF	PL0	All lamps OFF		X	X
Lamps ON	PL1	All lamps ON		X	X
Program UP	PsU	Jump to next program		X	X
Program Down	PsD	Return to previous program			X
Set Program	PSxx	xx is the decimal representation of the program number (01 - 14)	PS06 = jump to program 6		X
Auto sync procedure	PsS	executes the auto sync procedure (see page 10)		X	X
White 1	PW1	Jump to White 1 (program 12)			X
White 2	PW2	Jump to White 2 (program 13)			X
White 3	PW3	Jump to White 3 (program 14)			X
Set RGB	PCrrrgggbbb	rrr, ggg and bbb are the decimal representation of the RGB value (with leading zero s)	1) PC255128064 = Full output level on Red color, half output level on Green color, 1/4 output level on Blue color 2) PC255252555 = All colors at full output level 3) PC000000000 = All colors OFF		X
Set Dim value	PDxxx	set the OUTPUT value of the lamp in % (000 - 100)	PD075 = 75% output level (on all LEDs)		X
set DMX startAddress	PAxxxxyz	y = 'e' or 'E'	PA035E = set DMX start address to 35 [35(R), 36(G), 37(B)]		X
Set color in percentage	Pprgbe	variable size, rgb = ASCII 0-255, e = end character	Pp25050100e = Red 25%, Green 50%, Blue 100%		X
Set color in hex	Pcrgbe	variable size, rgb = ASCII 0-255, e = end character	Pc64128255e = Red 25%, Green 50%, Blue 100%		X
Relay A control	PRAx	x = 1 (ON), 0 (OFF), P (Pulse) this overrides dipswitch	PRA1 = Relay A ON PRA0 = Relay A OFF	X	X
Relay B control	PRBx	x = 1 (ON), 0 (OFF), P (Pulse) this overrides dipswitch	PRB1 = Relay B ON PRB0 = Relay B OFF	X	X
ON/OFF relay control	PRMx	x = 1 (ON), 0 (OFF)	PRM1 = Relay ON/OFF control ON	X	X
Color temperature	PTxyz	x = ten thousand ; y = thousand ; z = hundred	PT035 = Set white color temperature to 3500K (in steps of 500K)		X

Procédure de réinitialisation (RESET)

Procédure de réinitialisation du circuit imprimé

- 1) Assurez-vous que le PLP-REM-350 est sous tension
- 2) Appuyez et maintenez le bouton RÉINITIALISER sur la carte logique
- 3) La LED bleue s'allume
- 4) La LED bleue s'allumera. Relâchez la touche RÉINITIALISER lorsque la LED bleue s'éteint

 La carte de commande a été RÉINITIALISÉ.
et tous les émetteurs ont été désaccouplés.

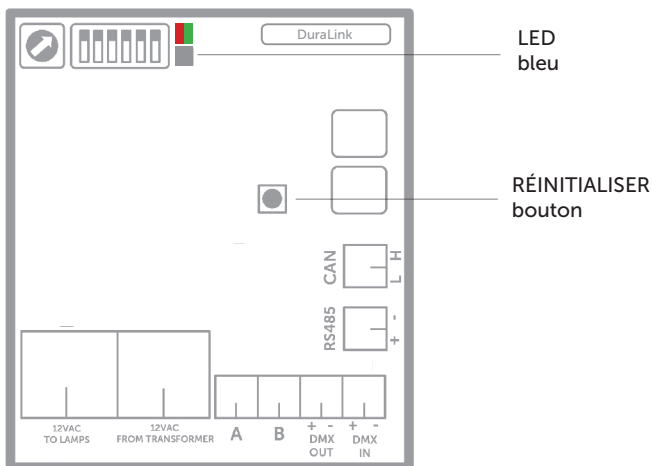

Pile de la télécommande

Remplacez la pile de la télécommande :

- Retirez la vis cruciforme et ouvrez la télécommande
 - Remplacez la pile, en veillant à respecter la polarité
- Type de pile : A23 12V

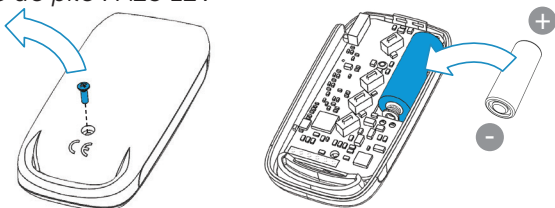

Résolution des problèmes

PROBLÈME

Le PLP-REM ne réagit pas aux commandes de la télécommande

SOLUTION

- Suivez la procédure de réinitialisation
- Vérifiez la pile de la télécommande portable (voir p. 52)
- La télécommande n'a pas été appairée correctement avec le PLP-REM. Répétez le processus d'appairage (voir p. 52)
- Réduisez la distance entre la télécommande portable et le PLP-REM et/ou éliminez les obstacles
- Vérifier le voyant d'état général sur la carte logique. S'il est rouge, la tension secondaire est trop élevée (> 14VAC) ou il y a un court-circuit.
- Vérifiez la LED sur le petit circuit imprimé DURALINK (coin supérieur droit). Cette LED doit clignoter chaque fois qu'un bouton de l'émetteur est enfoncé. Si le voyant fonctionne, il peut y avoir un problème avec la carte mère

Les lumières de la piscine ne fonctionnent pas ou ne change pas de couleurs correctement

- Suivez la procédure de réinitialisation
- Vérifiez si tous les raccordements ont été réalisés selon le schéma électrique
- Mettez le PLP-REM en mode ON/OFF (interrupteur DIP n ° 1) et vérifiez si les lampes fonctionnent.

L'émetteur à main ne fonctionne plus après la mise à jour du firmware du PLP-REM-350 pour la compatibilité LinkTouch

- Achetez un nouvel émetteur TX868 avec firmware mis à jour

Instructions de câblage de la piscine



WARNING



- (GB) Cable installation guidelines**
- (NL) Richtlijnen voor bekabeling**
- (DE) Anleitung zur Verkabelung**
- (FR) Instructions de câblage**
- (IT) Istruzioni di collegamento**
- (ES) Instrucciones para ajuste del cableado**

Please refer to the manual of your DURAVISION® pool light



Manual downloads:
www.duratech.be/downloads

Not following the instructions for cable cross section and transformer VA ratings may result in lamp malfunctioning and may result in having to rewire the installation. The manufacturer's warranty does not apply in this situation.

Veillez vous référer au manuel de votre lampe de piscine DURAVISION pour des informations détaillées sur la section de câble et la longueur maximale.

Instructions de câblage - remarques

1. Autres équipements comme variateurs de fréquence ou les moteurs électriques peuvent générer un bruit excessif sur la ligne électrique 230 VAC / 400 VAC.
Ce bruit pourrait être injecté dans la ligne électrique 12VAC adjacente et perturber la communication des signaux vers les lumières DURAVISION

 **Gardez les câbles de ligne 230 VAC / 400 VAC au moins 50cm séparés sur leur longueur totale de la ligne 12 VAC vers toutes les lumières RGB**

 **Ne pas mélanger les câbles de ligne 12 VAC et 230 VAC / 400 VAC dans les mêmes goulottes de câbles.**

2. Des fils non-utilisés dans un câble multiconducteurs ne sont pas autorisés cars ils perturbent la communication PLC.

 **Nous vous recommandons d'utiliser câbles à 2 fils pour toutes les lampes Adagio Pro afin d'éviter les problèmes de communication PLC**

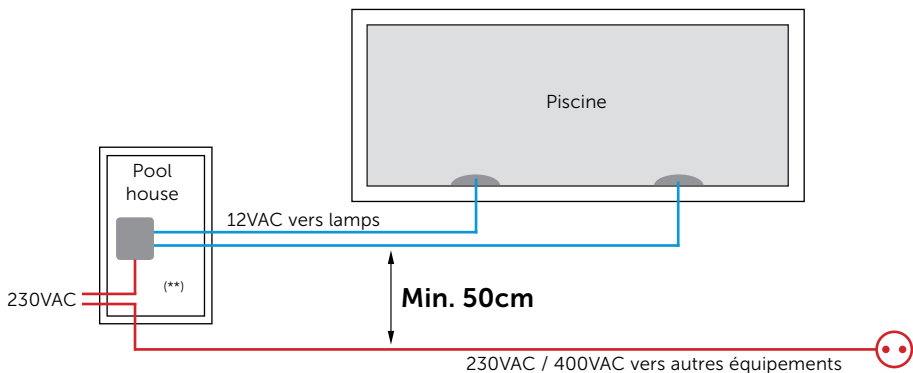

() Ne pas mélanger les câbles de ligne 12 VAC et 230 VAC / 400 VAC dans les mêmes goulottes de câbles.**

Inhalt

Technische Angaben	
Allgemeine Spezifikation	Seite 58
PLP-REM-350 Übersicht	Seite 58
Logikplatine	Seite 59
Installationsanweisungen	
Einzelinstallation der PLP-REM-350 Einheit	Seite 60
Mehrfachinstallation von PLP-REM-350	Seite 61
Betriebsarten	Seite 62
Funktionalitäten des DIP-schalters	Seite 63
Funktionen des Senders	
Betriebsmodus: PLC	Seite 64
Betriebsmodus: ZWEIPUNKTS.....	Seite 64
Ersetzen der Sendertastatur.....	Seite 65
Handsender koppeln.....	Seite 65
DMX 512 Kommunikation	
Einzelinstallation der PLP-REM-350 Einheit	Seite 66
Mehrfachinstallation von PLP-REM-350	Seite 67
RS-485 Kommunikation	
Einzelinstallation der PLP-REM-350 Einheit	Seite 68
RS-485 Befehlssatz	Seite 69
RÜCKSTELL-Prozedur.....	Seite 70
Senderbatterie	Seite 70
Fehlerdiagnose.....	Seite 71
Anleitung zur Verkabelung	Seite 72
Verkabelung Bemerkung.....	Seite 74

DURALINK

Technische Angaben

Allgemeine Spezifikationen

Eingangsspannung:	230 VAC 50Hz
Ausgangsspannung:	12,5 VAC
VA-Nenngröße des Transformators:	350VA
Maximale Ausgangsleistung:	350 VA (12 VAC / 25A)
Max. Bemessungsrelaiskontakt A & B	16A / 250 VAC
Max. Schaltleistung A & B	4000VA
RF band	868 MHz
Umgebungstemperatur:	0°C bis +40°C
Luftfeuchtigkeit	10% to 90% RH - Nicht kondensierend
Schutzklasse:	IP54
IEC Schutzklasse:	Class II 

PLP-REM-350 Übersicht

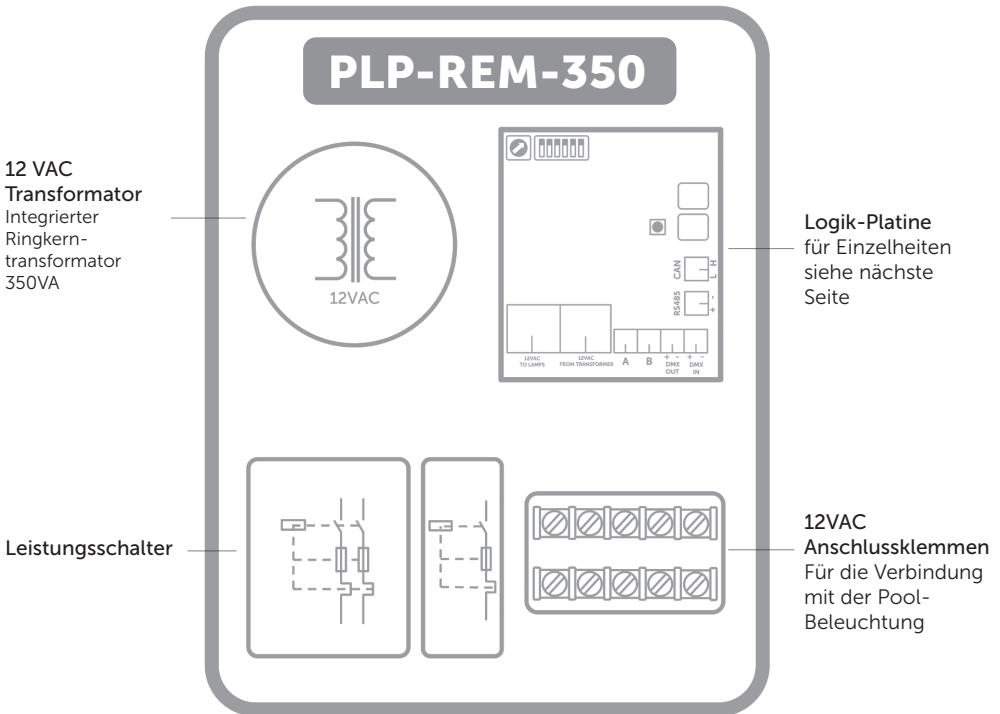

Logic-Platine

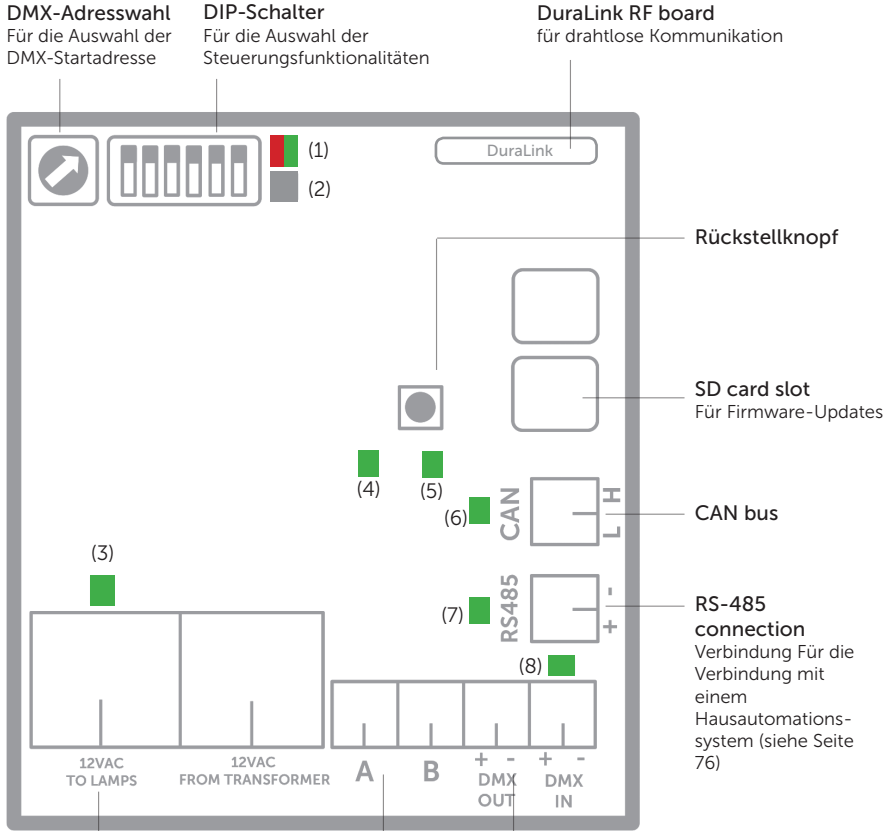

Status LEDs:

- (1) Allgemeiner Status
Grün = OK
Rot = Fehler Überspannung/Überstrom
- (2) RUCKSTELL Status
- (3) 12VAC zu Poolbeleuchtung (Grün = EIN)
- (4) Schalter A (Grün = EIN)
- (5) Schalter B Status (Grün = EIN)
- (6) CAN Status
- (7) RS-485 Signal
- (8) DMX Signal

Installationsanweisungen

Einzelinstallation der PLP-REM-350-Einheit

- Verbinden Sie eine 230VAC Stromquelle mit den 230VAC Anschlüssen des PLP-REM-350. Verbinden Sie die Poolbeleuchtung mit dem 12VAC Anschlussklemmen-Block im PLP-REM-350.
- Der PLP-REM-350 hat einen eingebauten 350VA Transformator. Die Gesamtstrombelastung der Poolbeleuchtung (+ Kabelverluste) kann das nicht übersteigen.

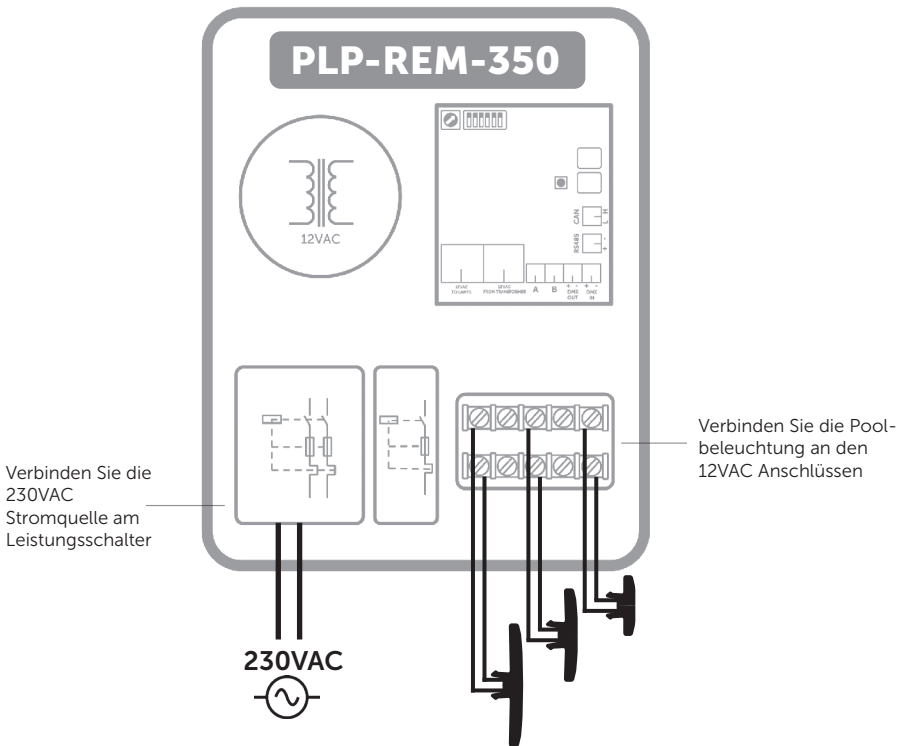

Mehrfachinstallation des PLP-REM-350

Für erweiterte Installationen (Insgesamt Lampenleistung > 350 VA) können mehrere PLP-REM-350 Einheiten miteinander verbinden. Auf diese Weise ist eine perfekte Synchronisierung aller Poollampen auch weiterhin gewährleistet

Die PLP-REM-350 Einheiten müssen miteinander kommunizieren, um sicherzustellen, dass alle Lampen perfekt synchronisiert sind.

Verbinden Sie die PLP-REM-350 Einheiten miteinander über den CAN bus
Verbinden Sie die CAN Anschlüsse der ersten PLP-REM-350 Einheit mit dem CAN Anschluss der zweiten PLP-REM-350 Einheit*

Falls mehr als zwei PLP-REM-350 Einheiten notwendig sind, verketteten Sie jeden CAN Anschluss mit dem entsprechenden CAN Anschluss der folgenden PLP-REM-350 Einheit (siehe unten). Beachten Sie die Polung der Anschlüsse! (CAN L & H)

Stellen Sie als nächstes die DIP-Schalter am PLP-REM-350 auf die richtige MASTER / SLAVE-Einstellung. Der erste PLP-REM-350 wird der Master sein. Alle anderen sind Sklaven. Informationen zu den Master / Slave-DIP-Schaltern finden Sie auf Seite 69.





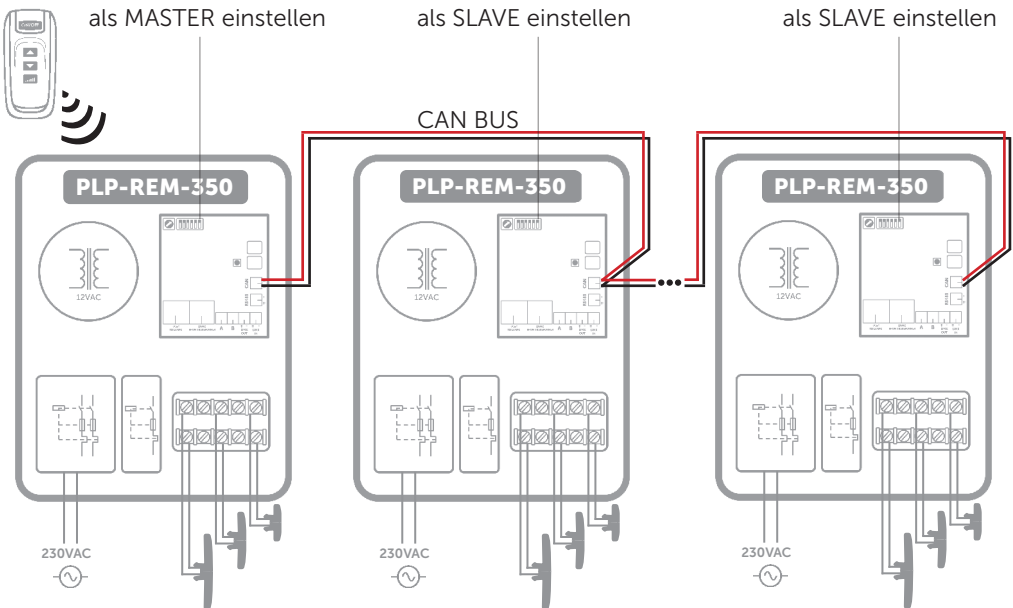









In einem Master / Slave-Setup reagiert nur der als MASTER eingestellte PLP-REM-350 auf Senderbefehle. Alle zusätzlichen Sender müssen mit diesem MASTER PLP-REM-350 gekoppelt werden



* Wir empfehlen die Verwendung eines geschirmten Twisted-Pair-Kabels (min. 0,5 mm² - bis zu 200 m) zum Anschließen mehrere PLP-REM-350 über den CAN-Bus.

Betriebsarten

Die PLP-REM-350-Steuerung hat 2 Hauptbetriebsarten:
 „der Modus Zweipunktsteuerung“ & „der Modus PLC-Steuerung“. Jeder Modus hat seine eigenen Funktionalitäten:

	Zweipunktsteuerung	PLC Steuerung
Kompatible Lampen	 VISION Adagio Pro	 VISION Adagio Pro  VISION Pro
	 VISION Spectra	
	 VISION Moonlight	
Lampen ein/ausschalten	JA	JA
Lampenfarbe ändern	JA ⁽¹⁾	JA ⁽¹⁾
Steuert Relay A & B	JA	JA
Dimmt die Lampen	NEIN	JA ⁽¹⁾
DMX Steuerung	NEIN	JA
RS-485 Steuerung	JA ⁽²⁾	JA
DIP Schalter Einstellung	DIP 1 EIN	DIP 1 AUS
Fernbedienungstastatur typ ⁽³⁾	   	   

1) Nur für RGB Lampen

2) Bei der Zweipunktsteuerung sind nur wenige RS-485 Befehle verfügbar (siehe Seite 69)

3) Abhängig davon, welcher Steuerungsmodus ausgewählt ist, muss die Tastatur oder der Sender getauscht werden

DIP-Schalter-Funktionalitäten

Die DIP-Schalter auf der Hauptplatine des PLP-REM-350 ermöglicht es den Benutzern, selbst festzulegen, wie die PLP-REM-350 funktioniert.

⚠ VORSICHT: Schalten Sie immer die Netzspannung aus PLP-REM-350, bevor Sie die DIP-Schalter wechseln

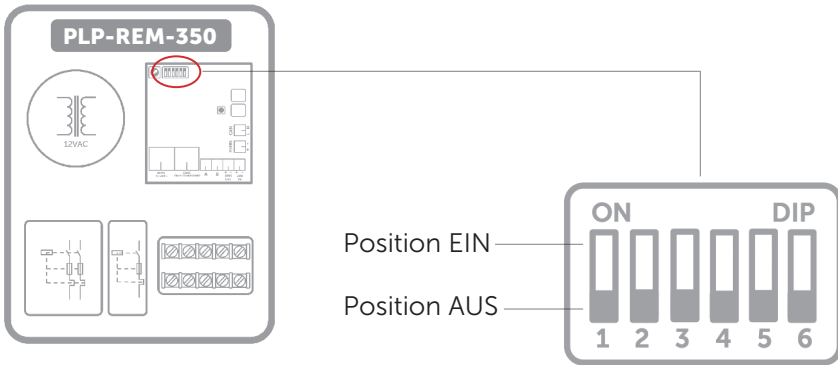

		DIP SWITCH					
Function	Einstellung	1	2	3	4	5	6
Betriebsmodus	Zweipunkt	EIN					
	PLC	AUS					
Relay A	PULS-Modus		EIN				
	TOGGLE modus		AUS				
Relay B	PULS-Modus			EIN			
	TOGGLE Modus			AUS			
SCHNELLE DMX-EINSTELLUNG *	SCHNELL				EIN		
	STANDARD				AUS		
DMX	NO LOOP					EIN	
	LOOP					AUS	
MASTER/SLAVE modus	SLAVE						EIN
	MASTER						AUS

* Schnelle DMX-Einstellung
Nur für Adagio Pro Lampen ab 2018.

DE

Senderfunktionen

BETRIEBSMODUS: PLC (Standardmodus)

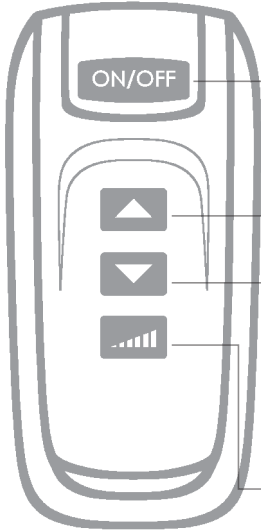

- Kurzes Drücken (<1 Sek.):**
Schaltet die Lampe zwischen EIN und AUS(1)
- Langes Drücken (>2 Sek.(2)):**
Alle Lampen & das „12VAC ZU LAMPEN“ Relay sind AUS⁽¹⁾-geschaltet
- Kurzes Drücken:**
Zum nächsten Farbprogramm wechseln
- Langes Drücken:**
Schaltet den Ausgang A AUS/EIN
- Kurzes Drücken:**
Zum vorangegangenen Farbprogramm zurückkehren
- Langes Drücken:**
Schaltet den Ausgang B AUS/EIN
- Kurzes Drücken:**
Nächsten Dimm-Schritt wählen:
100% -- 50% -- 25% ---> 100% -- ...
- Langes Drücken:**
Stellt die Lampen auf Programm 1 (blau) & volle Leuchtkraft

BETRIEBSMODUS: ZWEIPUNKT

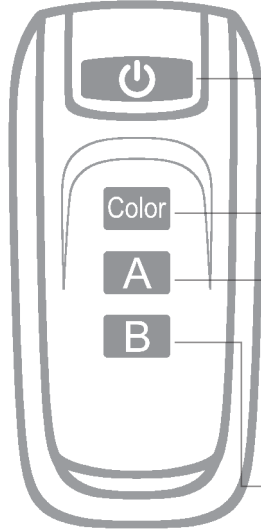

- Kurzes Drücken (<1 Sek.):**
Schaltet die Lampe zwischen EIN und AUS(1)
- Kurzes Drücken:**
Zum nächsten Farbprogramm wechseln
- Langes Drücken:**
Autosynchronisierungsprozedur⁽³⁾
- Kurzes Drücken:**
Schaltet den Ausgang A AUS/EIN
- Langes Drücken:**
/
- Kurzes Drücken:**
Schaltet den Ausgang B AUS/EIN
- Langes Drücken:**
/

(1) Der Status Lampe EIN oder AUS wird nach dem Ausschalten gespeichert
 (2) Die grüne LED Lampe auf dem Sender wird eingeschaltet, sobald Sie den Knopf drücken und schaltet sich nach 2 Sekunden aus, so wissen Sie genau, wann Sie den Knopf auslassen müssen.
 (3) Die Lampen werden für 30 Sekunden ausgeschaltet und dann 3 Mal EIN/AUS geschaltet. Das stellt alle Lampen auf Programm 1 ein: blau

Sendertastatur ersetzen

Abhängig vom ausgesuchten Steuermodus, muss man die Tastatur des Senders austauschen:

- Entfernen Sie die Kreuzschlitzschraube und öffnen Sie den Sender
- Ersetzen Sie die Tastatur am oberen Ende des Sendergehäuses
- Setzen Sie ihn wieder in umgekehrter Reihenfolge zusammen

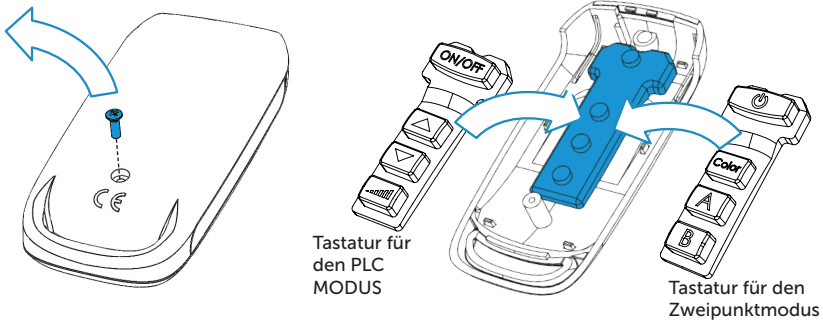

Kopplung des Handsenders mit der PLP-REM-350 Steuerung

Alle Handsendegeräte sind bereits werkseitig gekoppelt und bereit für die Verwendung. Im Falle, dass ein Problem auftaucht, kann der Kopplungsprozess wie unten beschrieben durchgeführt werden:

- 1) Drücken Sie die Paarungstaste auf der kleinen Leiterplatte im PLP-REM-350
---> Die BLAUE LED beginnt zu blinken
- 2) Innerhalb von 25 Sekunden drücken Sie eine beliebige Taste auf dem Handgerät.
---> Wenn die Fernbedienung korrekt gekoppelt wurde, wird die BLAUE LED-Anzeige fünf Mal langsam blinken
---> **ENTKOPPELN:**
Siehe RÜCKSTELL-Prozedur: Seite 70)

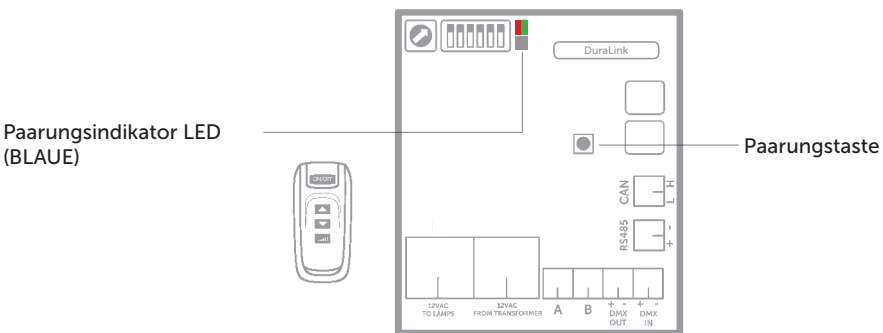

DMX 512 Kommunikation

Einzelninstallation der PLP-REM-350-Einheit

- 1) Achten Sie darauf, dass der DIP-Schalter 1 ausgeschaltet ist.
- 2) Vergewissern Sie sich, dass die Lampen mit der Fernbedienung eingeschaltet sind.

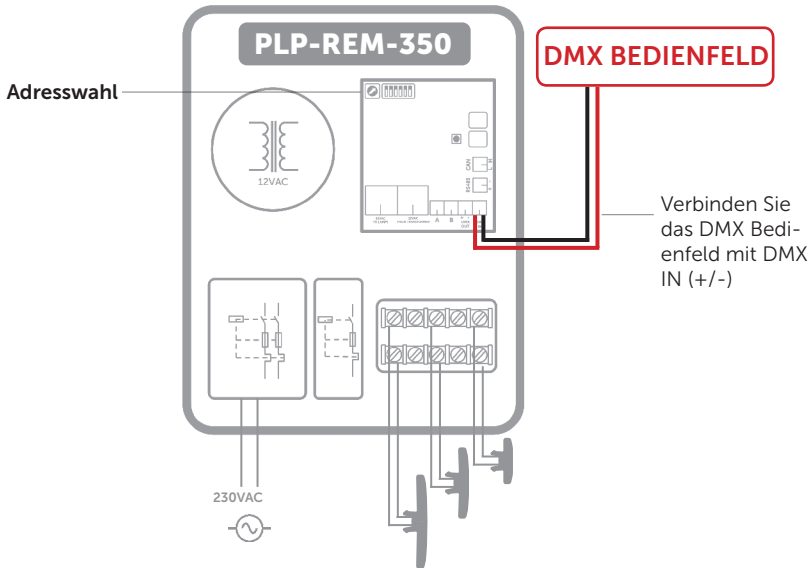

Adresswahleinrichtung

Die Einrichtung der DMX-Adresse des PLP-REM-350:
Wählen Sie die gewünschte Nummer auf der Adresswahl. Die gewählten Nummern bestimmen die DMX-Adressen des PLP-REM-350 & der Lampen. Jede Lampe braucht 3 Bytes der DMX Daten (R-G-B) und alle Lampen empfangen die gleichen DMX-Daten vom PLP-REM-350.

Adresswahl Position	0			1			2			...
	R	G	B	R	G	B	R	G	B	...
DMX adresse	1	2	3	4	5	6	7	8	9	...

Die DMX-Startadresse kann mit Hilfe des RS-485 Befehles außer Kraft gesetzt werden: „DMX-Startadresse einrichten“ (Siehe Seite 69)

! Anmerkung:

Im DMX512-Betrieb kann der Handsender weiterhin eine von drei Dimmstufen auswählen und die Lampen weiterhin schalten. Dies kann nicht durch DMX512-Daten überschrieben werden.

Mehrfachinstallation von PLP-REM-350-Einheiten

- 1) Verbinden Sie das DMX Bedienfeld mit dem "DMX IN" Anschluss auf dem ersten PLP-REM-350
- 2) Verbinden Sie die PLP-REM-350 Einheiten miteinander (offene Schleife):
DMX OUT --> DMX IN (gepolte Anschlüsse + -)
- 3) Richten Sie jeweils eine DMX Adresse für jede PLP-REM-350 Einheit über die Adresswahl ein.
 - Option 1: Alle PLP-REM-350 Einheiten können auf die gleiche Adresse eingerichtet werden:
Das hat zur Folge, dass alle Lampen die gleichen DMX Daten erhalten werden und identisch funktionieren werden
 - Option 2: Die PLP-REM-350 können auf unterschiedliche Adressen eingerichtet werden:
Jede PLP-REM-350 Einheit wird ihre eigenen Gruppe von verbundenen Lampen haben, die identisch funktionieren werden. Da jedoch jede PLP-REM-350 Einheit ihre eigene eindeutige Adresse hat, können die verschiedenen Lampengruppen separat gesteuert werden

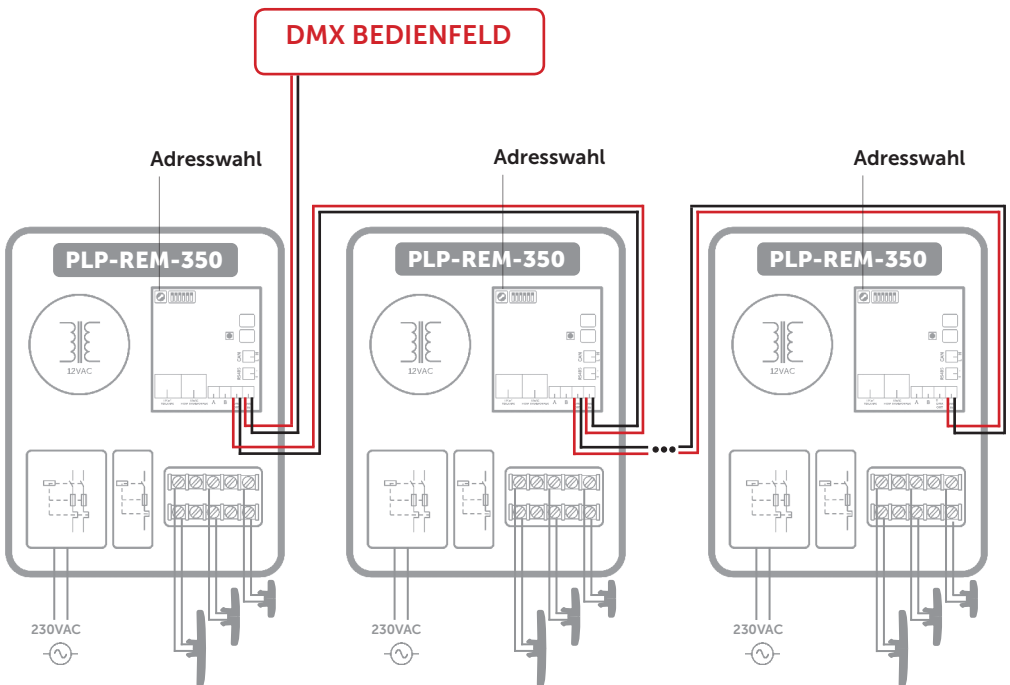

RS-485 Kommunikation

Einzelinstallation der PLP-REM-350-Einheit

- 1) Achten Sie darauf, dass der DIP-Schalter 1 ausgeschaltet ist.
- 2) Vergewissern Sie sich, dass die Lampen mit der Fernbedienung eingeschaltet sind.
- 3) Verbinden Sie die RS-485 Quelle am "485" Anschluss an der PLP-REM-350 Einheit
- 4) Kommunikationseinstellungen: 9600, 8, 1, n
- 5) Befehlsliste: siehe Seite 69

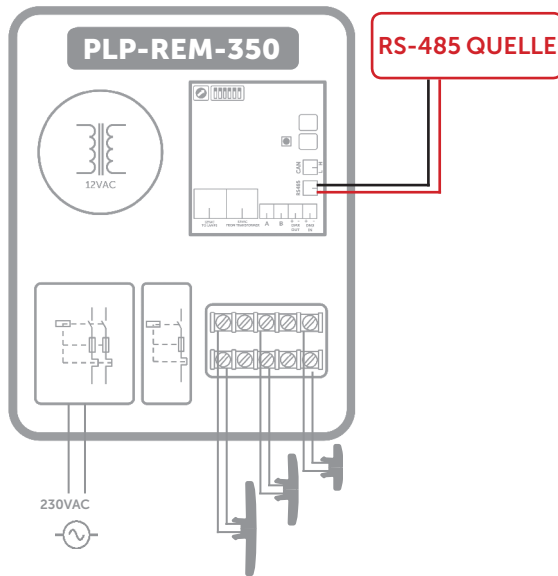

Mehrfachinstallation von PLP-REM-350-Einheiten

- 1) Verbinden Sie die PLP-REM-350 über den CAN-Bus miteinander (siehe Seite 67)
- 2) Stellen Sie sicher, dass der DIP-Schalter 1 auf AUS steht
- 3) Vergewissern Sie sich, dass die Lichter mit der Fernbedienung eingeschaltet sind.
- 4) Schließen Sie den ersten PLP-REM-350 wie beschrieben an die RS-485-Quelle an über. Dieser PLP-REM wird der Master sein.
- 5) Kommunikationseinstellungen und Befehlsliste: siehe oben

RS-485 Command set

Command	Command	Remark	Example	available in ON/OFF mode	available in PLC mode
Lamps OFF	PL0	All lamps OFF		X	X
Lamps ON	PL1	All lamps ON		X	X
Program UP	PsU	Jump to next program		X	X
Program Down	PsD	Return to previous program			X
Set Program	PSxx	xx is the decimal representation of the program number (01 - 14)	PS06 = jump to program 6		X
Auto sync procedure	PsS	executes the auto sync procedure (see page 10)		X	X
White 1	PW1	Jump to White 1 (program 12)			X
White 2	PW2	Jump to White 2 (program 13)			X
White 3	PW3	Jump to White 3 (program 14)			X
Set RGB	PCrrrgggbbb	rrr, ggg and bbb are the decimal representation of the RGB value (with leading zero's)	1) PC255128064 = Full output level on Red color, half output level on Green color, 1/4 output level on Blue color 2) PC255252555 = All colors at full output level 3) PC000000000 = All colors OFF		X
Set Dim value	PDxxx	set the OUTPUT value of the lamp in % (000 - 100)	PD075 = 75% output level (on all LEDs)		X
set DMX startAddress	PAxxxxyz	y = 'e' or 'E'	PA035E = set DMX start address to 35 [35(R), 36(G), 37(B)]		X
Set color in percentage	Pprgbe	variable size, rgb = ASCII 0-255, e = end character	Pp25050100e = Red 25%, Green 50%, Blue 100%		X
Set color in hex	Pcrgbe	variable size, rgb = ASCII 0-255, e = end character	Pc64128255e = Red 25%, Green 50%, Blue 100%		X
Relay A control	PRAx	x = 1 (ON), 0 (OFF), P (Pulse) this overrides dipswitch	PRA1 = Relay A ON PRA0 = Relay A OFF	X	X
Relay B control	PRBx	x = 1 (ON), 0 (OFF), P (Pulse) this overrides dipswitch	PRB1 = Relay B ON PRB0 = Relay B OFF	X	X
ON/OFF relay control	PRMx	x = 1 (ON), 0 (OFF)	PRM1 = Relay ON/OFF control ON	X	X
Color temperature	PTxyz	x = ten thousand ; y = thousand ; z = hundred	PT035 = Set white color temperature to 3500K (in steps of 500K)		X

RÜCKSTELL-Prozedur (RESET)

RÜCKSTELL-Prozedur für die Steuertafel

- 1) Stellen Sie sicher, dass der PLP-REM-350 eingeschaltet ist
- 2) Halten Sie die RÜCKSTELL-Taste auf der Logikplatine gedrückt
- 3) Die blaue LED leuchtet auf
- 4) Lassen Sie die RÜCKSTELL-Taste los, wenn die blaue LED leuchtet

 Die Steuertafel wurde ZURÜCKGESTELLT und alle Sender sind ungepaart.

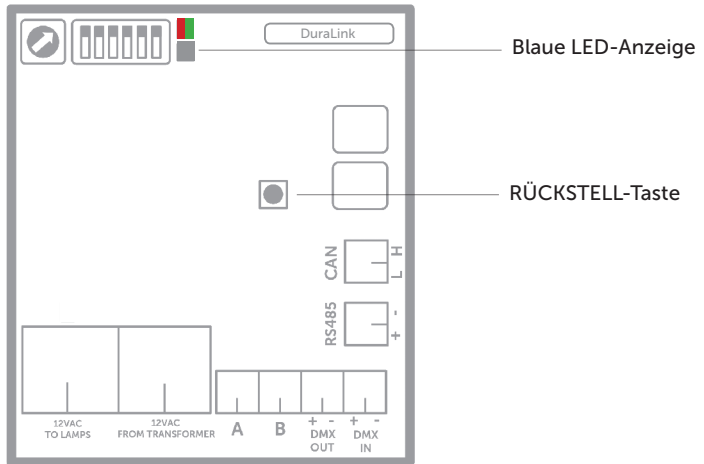

Senderbatterie

Ersetzen der Senderbatterie:

- Entfernen Sie die Kreuzschlitzschraube und öffnen Sie das Sendegerät
 - Ersetzen Sie die Batterie, achten Sie auf die Polung
- Batterietyp: A23 12V

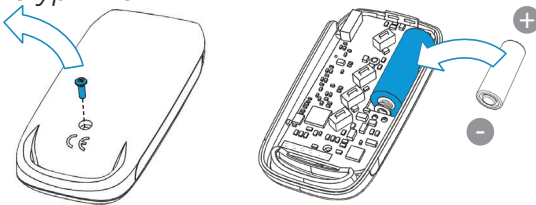

Fehlerdiagnose

PROBLEM

Der PLP-REM-350 reagiert nicht auf die Sender-Befehle

LÖSUNG

- Führen Sie eine RÜCKSTEL Prozedur durch
- Prüfen Sie die Batterie des Handsendegerätes (siehe Seite 72)
- Der Sender ist nicht korrekt mit dem PLP-REM-350 gekoppelt. Wiederholen Sie den Kopplungsprozess (siehe Seite 72)
- Verringern Sie die Entfernung zwischen dem Handsendegerät und der PLP-REM-350 Einheit und/oder entfernen Sie Hindernisse
- Überprüfen Sie die allgemeine Statusanzeige auf der Logikplatine. Wenn es rot ist, dann ist die Sekundärspannung zu hoch (> 14VAC) oder es ist ein Kurzschluss.
- Überprüfen Sie die LED auf der kleinen DURALINK-Platine (obere rechte Ecke). Diese LED muss jedes Mal blinken, wenn eine Sendertaste gedrückt wird. Wenn die LED funktioniert, liegt möglicherweise ein Problem mit der Hauptplatine vor

Die Poolbeleuchtung funktioniert nicht

- Führen Sie eine RÜCKSTEL Prozedur durch
- Prüfen Sie, ob alle Verbindungen entsprechend dem elektrischen Schema verbunden sind.
- Schalten Sie den PLP-REM in den EIN/ AUS-Modus (DIP-Schalter Nr. 1) und prüfen Sie, ob die Lampen funktionieren.

Der Handsender funktioniert nach einem Firmware-Update des PLP-REM-350 aus Gründen der Link-Touch-Kompatibilität nicht mehr

- Kaufen Sie einen neuen TX868-Sender mit aktualisierter Firmware

Anleitung zur Verkabelung



WARNING



- GB **Cable installation guidelines**
- NL **Richtlijnen voor bekabeling**
- DE **Anleitung zur Verkabelung**
- FR **Instructions de câblage**
- IT **Istruzioni di collegamento**
- ES **Instrucciones para ajuste del cableado**

Please refer to the manual of your DURAVISION® pool light



Manual downloads:
www.duratech.be/downloads

Not following the instructions for cable cross section and transformer VA ratings may result in lamp malfunctioning and may result in having to rewire the installation. The manufacturer's warranty does not apply in this situation.

Ausführliche Informationen zum Kabelquerschnitt und zur maximalen Länge finden Sie im Handbuch Ihrer DURAVISION Poolleuchte.

Verkabelung Bemerkung

1. Andere Geräte wie Frequenzumrichter und Elektromotoren können übermäßiges Rauschen an der Stromversorgung 230VAC / 400VAC erzeugen.
Dieses Rauschen könnte in die angrenzende 12VAC Stromleitung eingespeist werden und stören die Stromleitung Kommunikation zu den DURAVISION Lichter.

 Halten Sie 230VAC / 400VAC Stromleitung Kabel mindestens 50cm getrennt über ihre volle Länge von der 12VAC Stromleitung zu jedem RGB Lichter

 Mischen Sie keine 12VAC und 230VAC / 400VAC Netzkabel in das gleiche Kabeltrasse

2. Nicht verwendete Adern in einem mehradrigen Kabel sind nicht zulässig, da dies die PLC Kommunikation stört

 Wir empfehlen die Verwendung von 2-adriges Kabeln für alle Adagio Pro Leuchten, um PLC Kommunikationsproble zu vermeiden

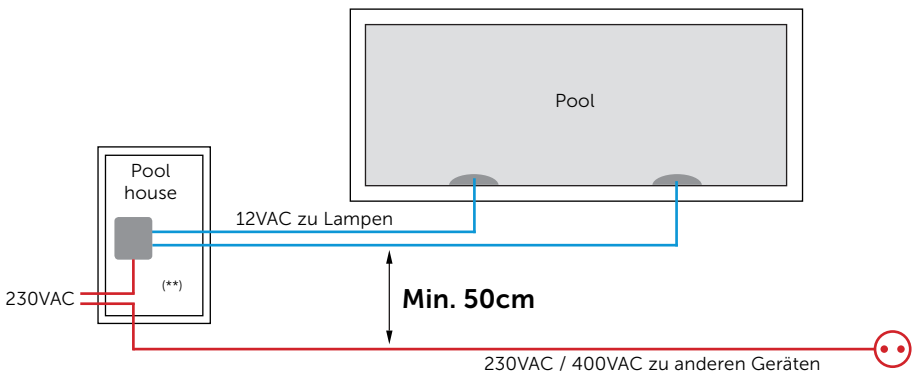

() Mischen Sie keine 12VAC und 230VAC / 400VAC Netzkabel in das gleiche Kabeltrasse**

Índice

Especcaciones técnicas	
Especcaciones generales	Page 76
PLP-REM-350 características	Page 76
Tablero lógico	Page 77
Instrucciones de instalación	
Unidad sencilla PLP-REM-350	Page 78
Instalación múltiple PLP-REM-350	Page 79
Modos de operación.....	Page 80
Funcionalidades del interruptor DIP	Page 81
Funciones del transmisor	
Modo de operación: CON./DESC	Page 82
Modos de operación: PLC.....	Page 82
Substitución del teclado del transmisor de mano	Page 83
Emparejamiento del transmisor de mano	Page 83
Comunicación DMX 512	
Unidad sencilla PLP-REM-350	Page 84
Instalación múltiple PLP-REM-350	Page 85
Comunicación RS-485	
Unidad sencilla PLP-REM-350	Page 86
Juego de comandos RS-485	Page 87
Procedimiento de REINICIO	Page 88
Pila del transmisor.....	Page 88
Reparación de averías de averías	Page 89
Instrucciones de cableado	Page 90
Cableado notas	Page 92

DURALINK

Especificaciones técnicas

Especificaciones generales

Voltaje de entrada:	230 VAC 50 Hz
Voltaje de salida:	12 VAC
Potencia máxima de salida	350VA (12 VAC / 25A)
Índice máximo de contacto relé A y B	16A / 250 VAC
Potencia máxima de cambio A y B	4000VA
Banda RF	868 MHz
Temperatura del aire ambiente:	0°C to +40°C
Humedad	10% to 90% RH sin condensación
Índice de protección de acceso:	IP54
Clase de protección IEC:	Class II 

PLP-REM-350 características

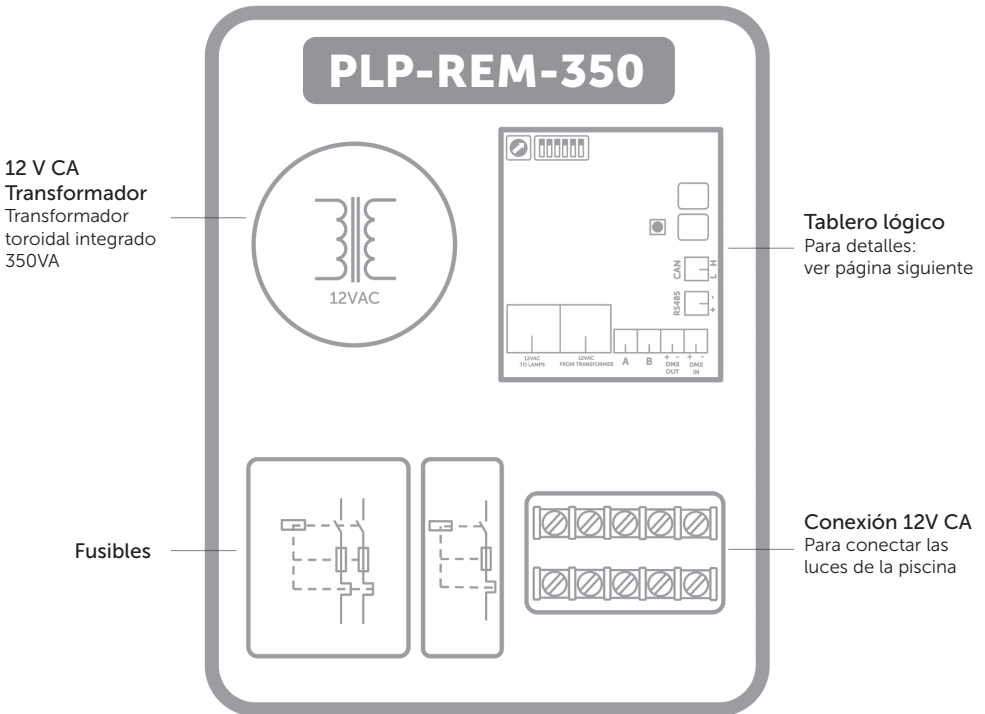

Tablero lógico

Dial de dirección DMX
Para elegir dirección de inicio DMX

Interruptor DIP
Para seleccionar Funcionalidades del regulador

Placa DuraLink RF
Para comunicación inalámbrica

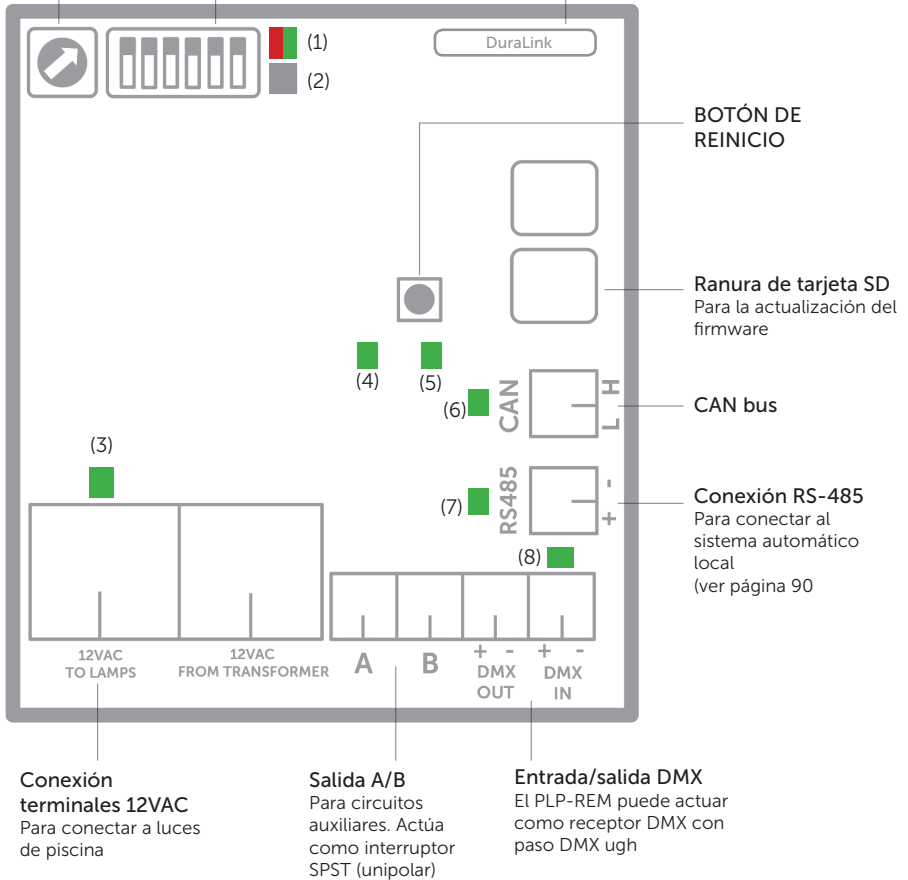

Estado LED:

- (1) Estado general
Verde = ACEPTABLE
Rojo = error sobretensión/sobrecorriente
- (2) Estado de REINICIO
- (3) 12 V CA a lámparas de piscina
- (4) Interruptor A (verde = ENCENDIDO)
- (5) Cambie el Estado de B
(verde = ENCENDIDO)
- (6) Estado CAN
- (7) Señal RS-485
- (8) Señal de DMX

Instrucciones de instalación

Sola unidad de PLP-REM-350

- Conecte una fuente de alimentación de 230 VCA a los terminales de 230 VCA del PLP-REM-350.
Conecte las luces de la piscina al terminal de conexión de 12VCA bloque en el PLP-REM-350.
- El PLP-REM-350 tiene un transformador de 350VA integrado. La carga de potencia total o las luces (+ pérdidas de cable) de la piscina no pueden exceder esto.

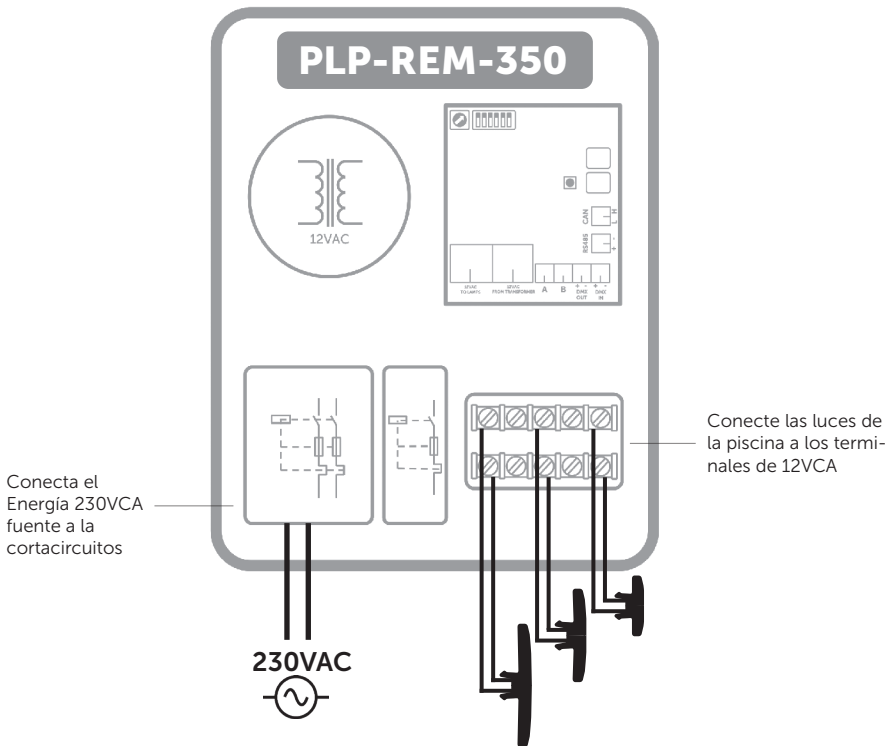

Instalación múltiple de PLP-REM-350

Para instalaciones extendidas (potencia total de la lámpara > 350 VA), se pueden vincular varias PLP-REM-350. De esta manera, se garantiza una sincronización perfecta de todas las luces de la piscina.

El PLP-REM-350 necesita comunicarse entre sí para garantizar que todas las lámparas estén en perfecta sincronización.

Se prefiere si varios PLP-REM-350 están a una distancia muy larga de cada uno.

Conecte los PLP-REM-350 entre sí con el bus CAN

Conecte los terminales CAN del primer PLP-REM-350 con el CAN terminal del segundo PLP-REM-350*

Si se necesitan más de 2 PLP-REM-350, simplemente conecte en cadena cada uno Terminal CAN con el del próximo PLP-REM-350 (ver más abajo). ¡Respete la polaridad de los terminales! (PUEDE L & H)

A continuación, configure los interruptores DIP del PLP-REM-350 en la configuración MASTER / SLAVE correcta. El primer PLP-REM-350 será el maestro. Todos los demás serán esclavos. Consulte la página 89 para obtener información sobre el interruptor DIP Master/Slave.





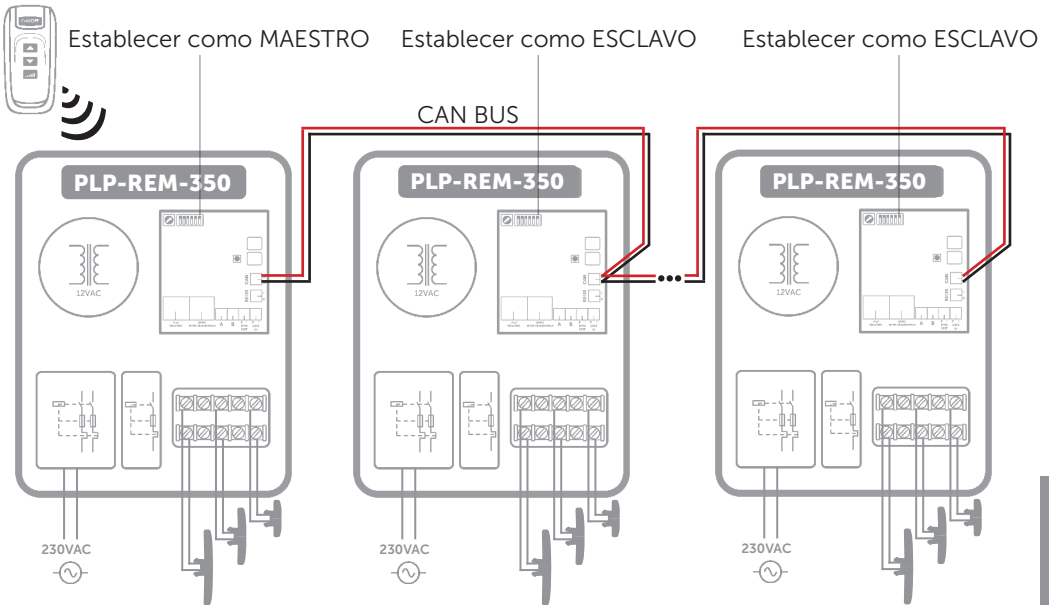









En una configuración Maestro / Esclavo, solo el PLP-REM-350 configurado como MAESTRO reaccionará a los comandos del transmisor. Cualquier transmisor adicional deberá emparejarse con este MASTER PLP-REM-350



* Recomendamos utilizar un cable de par trenzado apantallado (mín. 0,5 mm² - hasta 200 m) para conectar múltiples PLP-REM-350 utilizando el bus CAN.

Modos de operación

El controlador PLP-REM-350 tiene 2 modos de operación principales: "Modo de control CON./DESC." y "Modo de control PLC". Cada modo tiene sus propias funcionalidades:

	Control CONECTADO/ DESCONECTADO	Control del PLC
Lámparas compatibles	 VISION Adagio Pro  VISION Spectra  VISION Moonlight	 VISION Adagio Pro  VISION Pro
Cambiar lámparas CON./DESC.	Sí	Sí
Cambiar color de la lámpara	Sí ⁽¹⁾	Sí ⁽¹⁾
Operar relé A y B	Sí	Sí
Atenuación de las lámparas	NO	Sí ⁽¹⁾
Control DMX	NO	Sí
Control RS-485	Sí ⁽²⁾	Sí
Ajuste de los interruptores DIP	DIP 1 ENCENDIDO	DIP 1 APAGADO
Tipo del teclado remoto ⁽³⁾	   	   

1) Solamente para las lámparas RGB

2) En modo de control CON./DESC., solamente algunos comandos RS-485 están disponibles (véase p. 87)

3) Dependiendo del modo de control seleccionado, necesita cambiar el teclado del transmisor

Funcionalidades del interruptor DIP

El interruptor DIP en la placa de circuito principal del PLP-REM-350 permite que el usuario modifique la manera de actuar del PLP-REM.

⚠ PRECAUCIÓN: Apague siempre la fuente de alimentación principal al PLP-REM-350 antes de cambiar los interruptores DIP

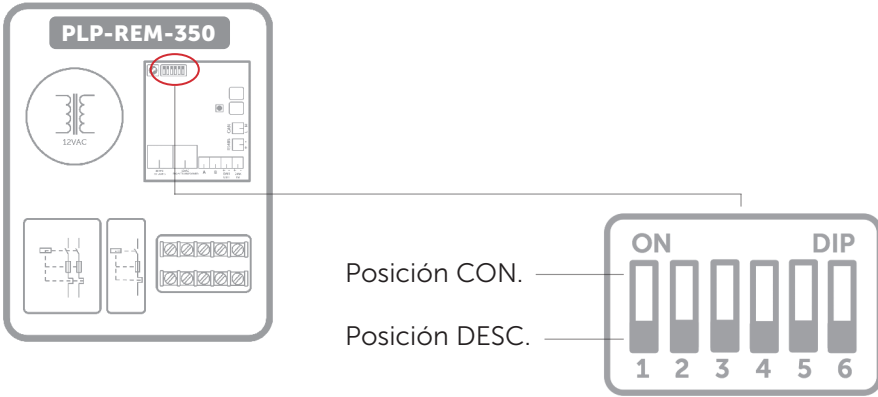

función	setting	DIP SWITCH					
		1	2	3	4	5	6
Modo de operación	CON./DESC.	CON					
	PLC	DES					
Relé A	Modo PULSACIÓN		CON				
	Modo CAMBIO		DES				
Relé B	Modo PULSACIÓN			CON			
	Modo CAMBIO			DES			
DMX RÁPIDO *	RÁPIDO				CON		
	NORMAL				DES		
DMX	SIN BUCLE					CON	
	BUCLE					DES	
Modo MAESTRO/ESCLAVO	ESCLAVO						CON
	MAESTRO						DES

* Configuración rápida de DMX
Solo para lámparas Adagio Pro desde 2018 y adelante

Funciones del transmisor

MODO DE OPERACIÓN: PLC (mode por defecto)

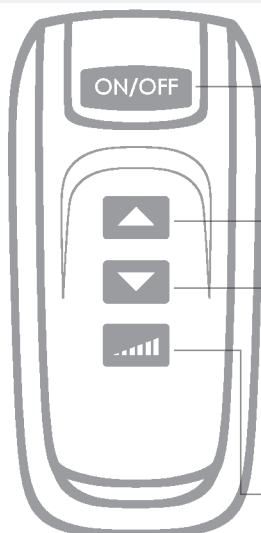

Pulsación corta (< 1 segundo):

Cambie la lámpara a CONECTADA o DESCONECTADA⁽¹⁾

Pulsación larga (> 2 segundos⁽²⁾):

Todos los relés de las lámparas de 12 V CA se DESCONECTAN ⁽¹⁾

Pulsación corta:

Vaya al siguiente programa de color.

Pulsación larga:

Cambie la salida A CON./DESC

Pulsación corta:

Vaya al programa del color anterior

Pulsación larga:

Cambie la salida B CON./DESC.

Pulsación corta:

Seleccione el siguiente nivel de atenuación:
100% -- el 50% -- el 25% ----> 100% -- ...

Pulsación larga:

Fije las lámparas en el Programa 1 (azul) brillo completo

MODO DE OPERACIÓN: ON/OFF

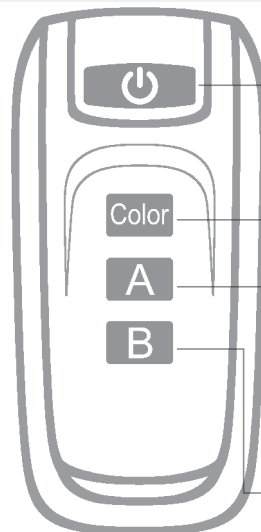

Pulsación corta (< 1 segundo):

Cambie la lámpara a CONECTADA o DESCONECTADA⁽¹⁾

Pulsación corta:

Vaya al siguiente programa de color

Pulsación larga:

Procedimiento de sincronización auto⁽³⁾

Pulsación corta:

Cambie la salida A CON./DESC.

Pulsación larga:

/

Pulsación corta:

Cambie la salida B CON./DESC

Pulsación larga:

/

(1) El estado CON./DESC. de la lámpara se memoriza después de desconectar

(2) El LED verde en el transmisor se encenderá tan pronto como usted comience a pulsar un botón, y parará después de 2 segundos, así que usted sabe exactamente cuándo soltar el botón.

(3) Las lámparas se apagarán durante 30 segundos y entonces cambian CON./DESC. 3 veces. Esto hará todas las lámparas en el programa 1: azul

Sustitución del teclado del transmisor (selección de modo de control)

Dependiendo del modo de control seleccionado, se necesita cambiar el teclado numérico del transmisor:

- Quite el tornillo y abra el transmisor
- Sustituya el teclado en la parte superior de la carcasa del transmisor
- Vuelva a montar en orden inverso

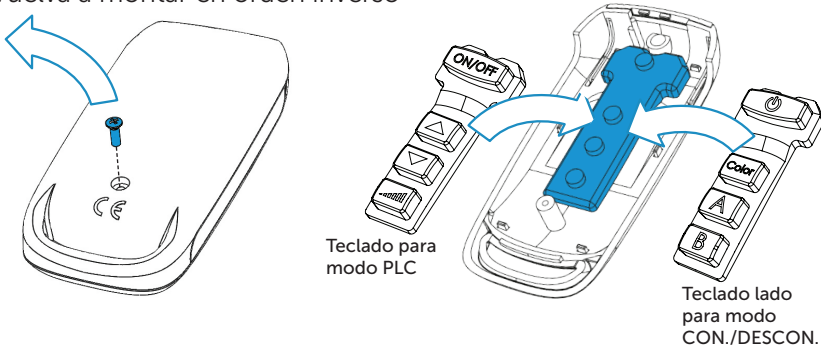

Emparejamiento del transmisor manual y el controlador PLP-REM-350

Todos los teledandos mandos a distancia ya están emparejados en fábrica y listos para el uso. En caso de que surja un problema, el proceso de emparejamiento se puede hacer como se indica a continuación:

- 1) Presione el botón de emparejamiento en la placeta electrónica, dentro del PLP-REM-350
----> El LED AZUL comenzará a parpadear
- 2) Dentro de 25 segundos, presione cualquier botón en el transmisor de mano.
----> Si el mando a distancia está correctamente sincronizado, el LED AZUL parpadeará lentamente 5 veces
----> **DESEMPAREJAR:**
Consulte el procedimiento RESET: en la página 88

Indicador LED de emparejamiento (azul)

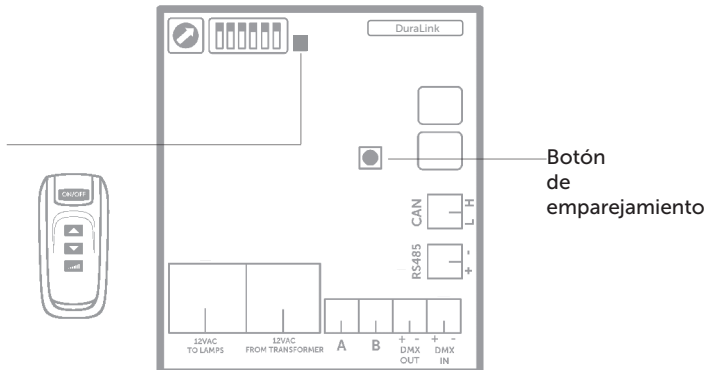

Comunicación de DMX 512

Unidad sencilla PLP-REM-350

- 1) Asegúrese de que el interruptor DIP 1 esté APAGADO.
- 2) Asegúrese de que las luces estén encendidas primero con el control remoto.

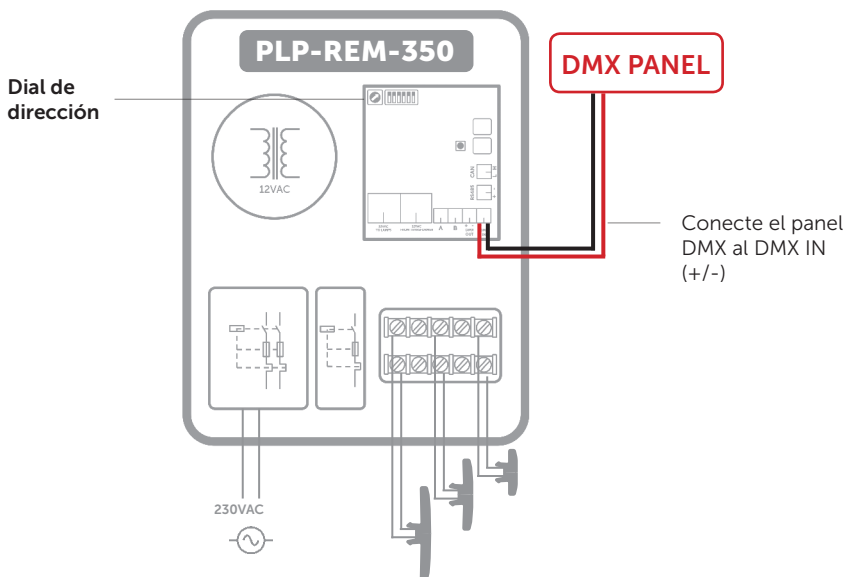

Con guración del dial de dirección

Determinación de la dirección DMX del PLP-REM-350:

Seleccione el número deseado en el dial de la dirección.

El número elegido determina las direcciones DMX del PLP-REM-350 y de las lámparas. Cada lámpara utiliza 3 bytes de datos DMX (R-G-B), y todas las lámparas reciben los mismos datos DMX del PLP-REM-350.

Posición del dial de dirección	0			1			2			...
	R	G	B	R	G	B	R	G	B	...
Dirección DMX	1	2	3	4	5	6	7	8	9	...

La dirección de comienzo de DMX se puede invalidar usando el comando RS-485: fije la dirección de comienzo de DMX" (véase la página 87)

! Observación:

Cuando está en funcionamiento DMX512, el transmisor de mano aún puede seleccionar uno de los tres niveles de atenuación y aún puede cambiar las lámparas. Esto no puede ser reemplazado por datos DMX512.

Instalación múltiple PLP-REM-350

- 1) Conecte el panel DMX al puerto "DMX IN" del primer PLP-REM
- 2) Conecte los PLP-REM-350s uno con uno (lazo abierto):
DMX OUT --> DMX IN (terminales polarizados + -)
- 3) Fije la dirección de DMX para cada PLP-REM a través del dial de la dirección.
 - Opción 1: Todos los PLP-REM-350 se van a la misma dirección:
Esto implica que todas las lámparas recibirán los mismos datos de DMX, Por lo tanto, todas actuarán idénticamente
 - Opción 2: Los PLP-REM-350 se puede van a diversas direcciones:
Cada PLP-REM-350 tiene su propio grupo de lámparas conectadas Que funcionan idénticamente.
Sin embargo, puesto que cada PLP-REM-350 tiene su dirección única, Los diversos grupos de lámparas se pueden controlar

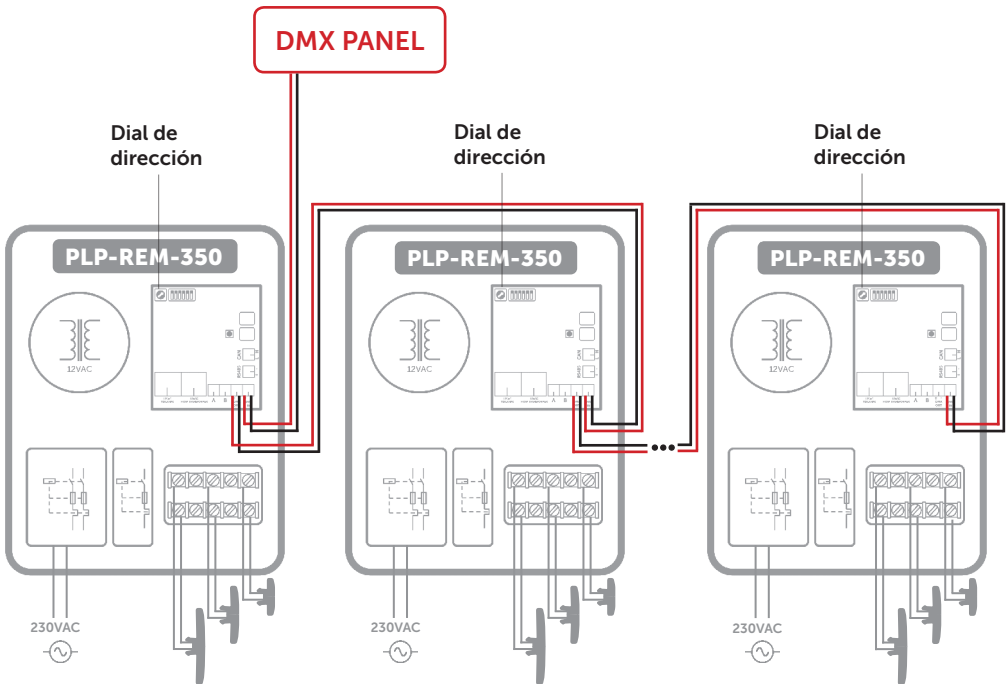

Comunicación RS-485

Unidad sencilla PLP-REM-350

- 1) Asegúrese de que el interruptor DIP 1 esté APAGADO.
- 2) Asegúrese de que las luces estén encendidas primero con el control remoto.
- 3) Conecte la fuente RS-485 con el puerto "485" en el PLP-REM
- 4) Ajustes de comunicación: 9600, 8, 1, n
- 5) Lista de comandos: vea la página 87

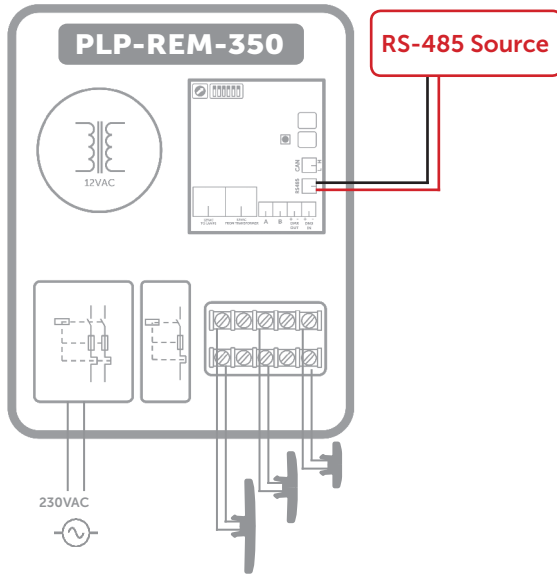

Instalación múltiple PLP-REM-350

- 1) Conecte los PLP-REM-350 entre sí a través del bus CAN (consulte la página 87)
- 2) Asegúrese de que el interruptor DIP 1 esté apagado
- 3) Asegúrese de que las luces estén encendidas con el control remoto primero.
- 4) Conecte el primer PLP-REM-350 con la fuente RS-485 como se describe encima. Este PLP-REM será el maestro.
- 5) Configuración de comunicación y lista de comandos: ver arriba

Juego de comandos RS-485

Command	Command	Remark	Example	available in ON/OFF mode	available in PLC mode
Lamps OFF	PLO	All lamps OFF		X	X
Lamps ON	PL1	All lamps ON		X	X
Program UP	PsU	Jump to next program		X	X
Program Down	PsD	Return to previous program			X
Set Program	PSxx	xx is the decimal representation of the program number (01 - 14)	P506 = jump to program 6		X
Auto sync procedure	P5S	executes the auto sync procedure (see page 10)		X	X
White 1	PW1	Jump to White 1 (program 12)			X
White 2	PW2	Jump to White 2 (program 13)			X
White 3	PW3	Jump to White 3 (program 14)			X
Set RGB	PCrrrgggbbb	rrr, ggg and bbb are the decimal representation of the RGB value (with leading zero's)	1) PC255128064 = Full output level on Red color, half output level on Green color, 1/4 output level on Blue color 2) PC25525255 = All colors at full output level 3) PC000000000 = All colors OFF		X
Set Dim value	PDxxx	set the OUTPUT value of the lamp in % (000 - 100)	PD075 = 75% output level (on all LED's)		X
set DMX startAddress	PAxxxxyz	y = 'e' or 'e'	PA035E = set DMX start address to 35 (35(R), 36(G), 37(B))		X
Set color in percentage	Pprgbe	variable size; rgb = ASCII 0-255, e = end character	Pp25050100e = Red 25%, Green 50%, Blue 100%		X
Set color in hex	Pcrgbe	variable size; rgb = ASCII 0-255, e = end character	Pc64128255e = Red 25%, Green 50%, Blue 100%		X
Relay A control	PRAX	x = 1 (ON), 0 (OFF), P (Pulse) lth is overrides dipswitch	PRA1 = Relay A ON PRA0 = Relay A OFF	X	X
Relay B control	PRBx	x = 1 (ON), 0 (OFF), P (Pulse) lth is overrides dipswitch	PRB1 = Relay B ON PRB0 = Relay B OFF	X	X
ON/OFF relay control	PRMx	x = 1 (ON), 0 (OFF)	PRM1 = Relay ON/OFF control ON	X	X
Color temperature	PTxyz	x = ten thousand ; y = thousand ; z = hundred	PT035 = Set white color temperature to 3500K (in steps of 500K)		X

Procedimiento de REINICIO

Procedimiento de REINICIO para el tablero de control

- 1) Asegúrese de que el PLP-REM-350 esté encendido
- 2) Mantenga presionado el botón REINICIO en la placeta electronica.
- 3) El LED azul se encenderá
- 4) Suelte el botón REINICIO cuando el LED azul se apague



*La tarjeta de control ha sido REINICIADO.
Y todos los telemandos han sido unpaired.*

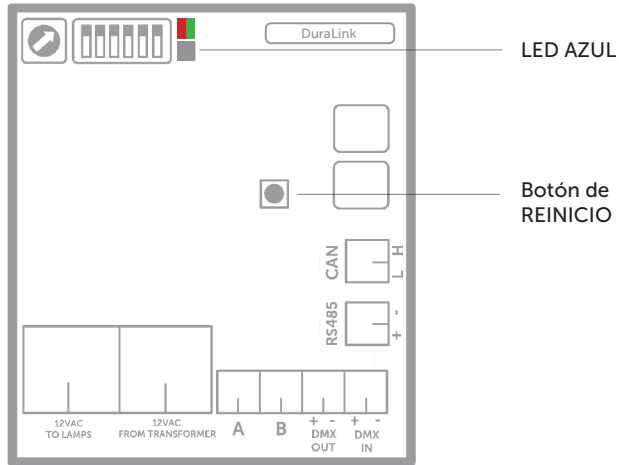

Pila del transmisor

Cambio de la pila del transmisor:

- Quite el tornillo con cabeza Philips y abra el telemandos
- Cambie la pila respetando la polaridad

Tipo de pila: A23 12V

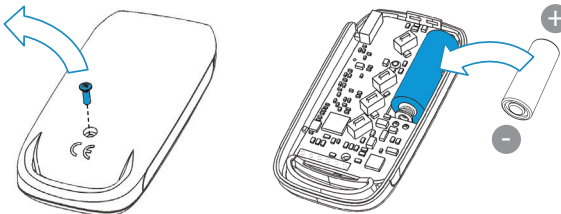

Reparación de averías

PROBLEMA

El PLP-REM-350 no reacciona a los comandos del telemandos

SOLUCIÓN

- Realice un procedimiento de REINICIO
- Compruebe la pila del transmisor de mano (véase p. 92)
- El transmisor no está bien emparejado con el PLP-REM-350. Repita el proceso de emparejamiento (véase p. 92)
- Reduzca la distancia entre el telemandos de mano y el PLP-REM-350 y/o quite los obstáculos
- Compruebe la luz de estado general en el tablero lógico. Si es roja, entonces el voltaje secundario es demasiado alto (>14V CA) o hay un cortocircuito
- Verifique el LED en la pequeña placa de circuito DURALINK (esquina superior derecha). Este LED debe parpadear cada vez que se presiona un botón del transmisor. Si el LED funciona, puede haber un problema con la placa lógica.

Las luces de la piscina no funcionan ni cambian los colores correctamente

- Realice un procedimiento de REINICIO
- Compruebe si todas las conexiones se hacen según el esquema eléctrico.
- Cambie el PLP-REM-350 al modo CON./DESC. (el No del interruptor DIP 1) y compruebe si las lámparas funcionan

El transmisor de mano ya no funciona después de la actualización del firmware del PLP-REM-350 para compatibilidad con Link-Touch

- Compre un nuevo transmisor TX868 que haya actualizado el firmware

Instrucciones de cableado de la luz de la piscina



WARNING



- GB Cable installation guidelines**
- NL Richtlijnen voor bekabeling**
- DE Anleitung zur Verkabelung**
- FR Instructions de câblage**
- IT Istruzioni di collegamento**
- ES Instrucciones para ajuste del cableado**

Please refer to the manual of your DURAVISION® pool light



Manual downloads:
www.duratech.be/downloads

Not following the instructions for cable cross section and transformer VA ratings may result in lamp malfunctioning and may result in having to rewire the installation. The manufacturer's warranty does not apply in this situation.

Consulte el manual de su luz para piscina DURAVISION para obtener información detallada sobre la sección transversal del cable y la longitud máxima.

Cableado notas

1. Otros equipos como los convertidores de frecuencia y los motores eléctricos pueden generar parasitos excesivos en el circuito de alimentación de 230VAC / 400VAC. Estos parasitos pueden penetrar el circuito de alimentación de 12VAC situado en la proximidad, y perturbar el circuito de alimentación hacia las lámparas DURAVISION.



Mantenga los cables del circuito de alimentación de 230VAC / 400VAC por lo menos 50cm separados sobre toda su longitud desde el circuito de alimentación de 12VAC hacia cualquier lámpara RGB



No mezcle cables del circuito de alimentación de 12VAC y 230VAC / 400VAC en el mismo conducto de cables

2. No se permiten núcleos no usado en un cable de varios nucleos porque perturba el comunicación el PLC



Recomendamos usar cables de 2-núcleos para todas la luces Adagio Pro para evitar los problemas de comunicación PLC.

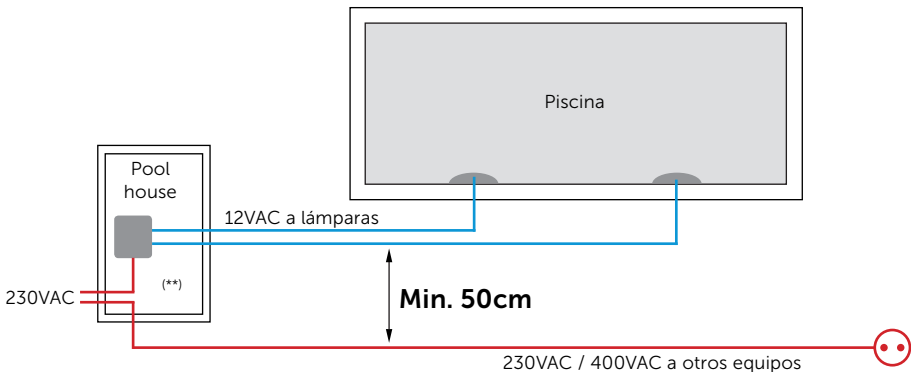

(**) No mezcle cables del circuito de alimentación de 12VAC y 230VAC / 400VAC en el mismo conducto de cables

Declaration of Conformity

We, Propulsion Systems bvba, declare under our sole responsibility, that the equipment described below conforms with the essential requirements of the following directives and standards:

DIRECTIVE 2011/65/EC (RoHs 2)

- EN 50581

DIRECTIVE 1999/5/EC Radio equipment and telecommunications terminal equipment and the mutual recognition of their conformity

- EN 300 220 Electromagnetic compatibility and Radio spectrum Matters (ERM); Short Range Devices (SRD); Radio equipment to be used in the 25 Mhz to 1000 Mhz frequency range with power levels ranging up to 500 mW

DIRECTIVE 2006/95/EC (LVD) Low Voltage Directive

- EN 61347-1 Control gear safety
- EN 61347-2-13 Control gear for LED modules

DIRECTIVE 2004/108/EC Electromagnetic compatibility

- EN 300 683 Electromagnetic compatibility and Radio spectrum Matters (ERM); Electromagnetic Compatibility (EMC) standard for Short Range Devices (SRD) operating on frequencies between 9 kHz and 25 GHz
- EN 301 489-3 Electromagnetic compatibility and Radio spectrum Matters (ERM); Electromagnetic Compatibility (EMC) standard for radio equipment and services, Part 3: Specific conditions for Short-Range Devices (SRD) operating on frequencies between 9 kHz and 40 GHz
- EN 55015:2009 EMC radio disturbance
- EN 61000-3-2:2009 EMC harmonic current
- EN 61547:2009 EMC immunity requirements

Equipment: handheld transmitter/receiver for remote control & base unit transmitter/receiver 868MHz band DuraLink™

Trade Mark: DURAVISION™

Model Nr.:

Description:

PLA-REM	Communications & remote control box for Adagio+ RGB DuraLink™
PLA-REM-300	300VA PSU & comms box for Adagio+ RGB DuraLink™
PL-REM	Remote control (ON/OFF) for DURAVISION lamps DuraLink™
PL-REM-P	Remote control (ON/OFF - Pulsed) for DURAVISION lamps DuraLink™
PL-REM-200	200VA PSU & remote control (ON/OFF) for DURAVISION lamps DuraLink™
PLP-REM	Communications & remote control box for DURAVISION lamps Duralink™
PLP-REM-300	300VA PSU & comms box for DURAVISION lamps DuraLink™
TX868-PLA	Transmitter; Duralink™ 868 MHz; for PLA-REM(-300)
TX868-PL	Transmitter; Duralink™ 868 MHz; for PL-REM(-60/200)
PLP-REM-350	350VA PSU & comms box for DURAVISION lamps DuraLink™
TX868	Transmitter; Duralink™ 868 MHz; for PL-REM(-60, -200) & PLP-REM(-300, -350)

Propulsion Systems bvba

Dooren 72
B-1784 Belgium

Date of signature: 10/09/2020

Signature:

Name: Mr. Marc Lamberts
Title: Managing Director



Contact details

Propulsion Systems bv
Dooren 72
1785 Merchtem, Belgium

Tel +32 2 461 02 53

www.duratech.be
info@propulsionsystems.be



DURALINK

